



— 2016 —

TOWING PRODUCT GUIDE



A SIMPLER AND MORE REWARDING TOWING EXPERIENCE

OUR MISSION, OUR PASSION.

MAKING THE TOWING EXPERIENCE SIMPLER AND MORE REWARDING THROUGH INNOVATION AND VALUE™

Founded in 1953 with headquarters in Emporia, KS, Hopkins® is recognized as the automotive industry leader in towing electrical products. Living by our mission, we strive to make the towing experience simpler and more rewarding through innovation and value. We follow a consistent philosophy, including: leveraging consumer insights to drive product innovation, utilizing our breadth of channel experience to optimize planogram assortments, driving comparable store growth through our step-up products, and delivering end-user value through efficient manufacturing/sourcing strategies. This value creation has helped our customers out-pace the growth of the overall market.



Simplifying the user experience is more than a mission statement to us, it is our passion. Today, more than 40% of retail category sales are generated from Hopkins® innovations and 9-out-of-10 DIY consumers rely on a Hopkins® wiring product solution for towing.



Innovative solutions include:

- Plug-In Simple!® Vehicle Wiring Kits
- Plug-In Simple!® Adapters (Endurance™, Multi-Tow®, LED Test, and Nite-Glow™)
- ENDURANCE™ Professional Grade Products
- ENGAGER™ Trailer Break-Away Systems
- INSIGHT™ Trailer Brake Control
- Innovation Award Winning Smart Hitch™ Camera and Sensor System
- Award Winning Packaging - creating the industry's most efficient space management and planogram navigation

As the leader and #1 brand of DIY electrical towing products we are on a mission to enhance the user towing experience while providing incremental sales opportunities for our customers.

CALL

(800) 524-1458

ONLINE

www.HopkinsTowingSolutions.com

EMAIL

sales@HopkinsMfg.com

FEATURED PRODUCTS

Hopkins® continues to introduce new and innovative products every year. Look closely for **NEW 2016** throughout this guide to find out more information about this year's introductions.



PAGE
22

INSIGHT™ BRAKE CONTROL

Trucks continue to evolve to meet consumer needs. It's time for brake controls to do the same. The InSIGHT™ brake control solves the problem of inconvenient mounting, out-of-reach controls and difficult to see displays.

NEW 2016

NITE-GLOW™ TRAILER CONNECTOR

LEDs will glow and confirm the electrical continuity when properly inserted into a tow vehicle connector. Connecting to a trailer no longer has to be a guessing game.

PAGE
31



NEW 2016

LED TEST TRAILER CONNECTORS

Available in 4 Flat, 5 Flat and 7 Blade, the LED Trailer Connector Family will save countless time and aggravation by confirming your vehicle and connector are not the problem when trailer lights aren't working.

PAGE
31



AWARD WINNING SMART HITCH™

The award winning Smart Hitch Camera and Sensor System eliminates the frustration of hitching up a trailer by yourself!



PAGE
42

TABLE OF CONTENTS PAGE

SHOPABILITY 4

Mobile Assistance 5

ENDURANCE™ 6

ADAPTERS 10

BRAKING 20

Break-Away Kits 26

TRAILER SIDE 28

Connector Sets 34

SPECIALTY 36

Test Equipment 39

Installation Components 39

Specialty Connectors 39

VEHICLE SIDE 40

Smart Hitch™ 42

Taillight Converters 48

Wiring Kits 50

5th Wheel Wiring Kits 85

Towed Vehicle Wiring Kits 86

LEVELS 90

VEHICLE LOOK-UP 94

INFORMATION 122

Brake Control Codes 123

Starter Kits 124

FAQ 126

Index 127

Contact / Warranty 131

AWARD WINNING INNOVATION BEYOND PRODUCT.

FOR THE CONSUMER

MORE INTUITIVE PLANOGRAM NAVIGATION

- Premium color segmentation by product type
- Increased visibility of “better/best” products
- Effective graphics, help guide and mobile assistance to help select the correct product

FOR THE RETAILER

INDUSTRY’S MOST EFFICIENT SPACE MANAGEMENT

- Smaller footprint with a standardized package height of 7”
- Better space utilization allowing for increased application coverage
- Increased GMROI



Refer to page 124 for a complete planogram example



A BETTER ONLINE EXPERIENCE.

www.HopkinsTowingSolutions.com and our mobile resources help consumers find the right products quickly and easily

INTUITIVE NAVIGATION

Whether a novice or experienced tower, our site provides built-in navigation tools to help your customer find the right product quickly and easily.

STEP-UP SALES SUPPORT

In every search result, we show consumers relevant step-up products. This helps build your market basket while increasing the consumers' satisfaction.

MORE THAN PRODUCT

Our site also features troubleshooting support, wiring guides and on-line installation instructions for every product we offer.



MOBILE HELP WHEN IT'S NEEDED



Our interactive website has been fully optimized for mobile devices, making it easy for consumers to access at all times. At retail, QR codes give access to helpful information that guides consumers to step-up options and cross-sell opportunities.



SEE HOW IT WORKS.

Scan here to interact with our website through your mobile device

ULTIMATE PERFORMANCE

Utilizing years of experience, we have completely rethought trailer wiring. The result is a new standard for premium-grade towing electrical products we call Endurance™. Extensive field research has shown that standard connectors do not meet consumers' expectations for durability and ease of use.

Endurance™ Professional Grade products are designed with maximum durability, enhanced weatherproofing and superior ergonomics backed by the industry's best 3-year performance guarantee.



"This thing did not disappoint. It's easy to install, rugged, and I don't need to worry about snapping the lid off."

- Adam S.

THE ENDURANCE™ ADVANTAGE

MAXIMUM DURABILITY

Over-built components, dust covers and internal seals make for long lasting performance



SUPERIOR ERGONOMICS

Larger, more intuitive grips for connecting and disconnecting ease



ENDURANCE™

PROFESSIONAL GRADE



STEP UP TO ENDURANCE™
Scan this QR code to experience the quality

MAXIMIZED SALES GROWTH

Elevated product performance provides for greater product worth in the eyes of the consumer. For our retailers, this translates into higher ticket rings, stronger comp sales and more satisfied customers.

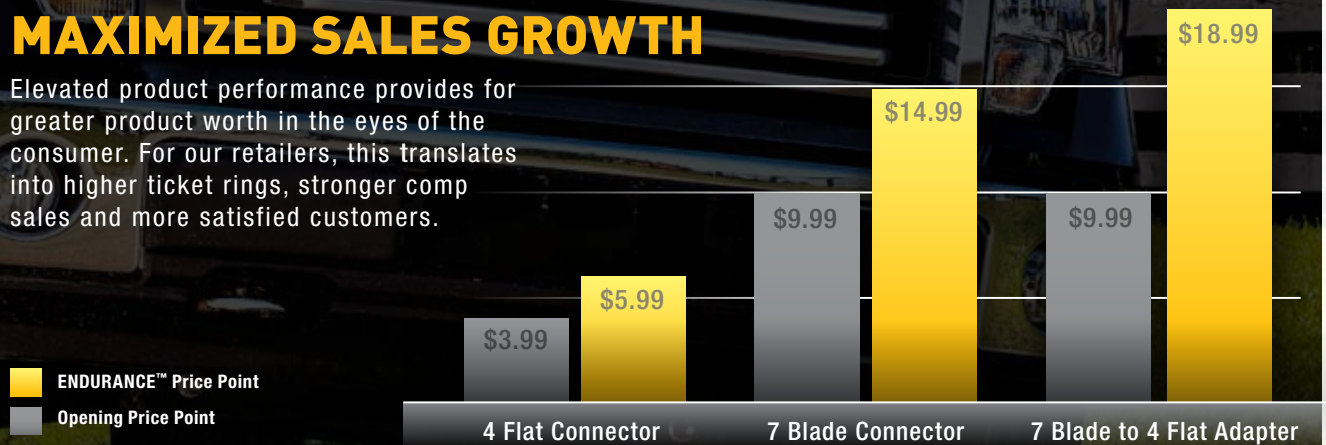

Endurance™ delivers a 50-90% increase in top-line sales performance over the opening price point

PREMIUM PACKAGING

Consumer-oriented packaging that invites users to see the difference



BEST WARRANTY

Endurance™ offers a 3-year warranty, the industry's best



PLUG-IN SIMPLE!® ADAPTERS



PATENTED
20049

7 Blade to 7 Blade Extension

- Extends the reach of the gooseneck or 5th Wheel connector to the back of the tow vehicle
- Length, 8 feet
- Heavy-duty connectors and cable



PATENTED
47570

Multi-Tow® 7 Blade to 6, 5 & 4

- Patented Quick-Change™ plug quickly accommodates both 6 pole wiring codes
- Provides four towing options from a single device



PATENTED
47390

Flex Adapter 7 Blade to 5 Flat

- Provides for a flexible reach
- Includes function testing LEDs
- Easy-pull grip design
- Dust cover and protected wire for added durability



PATENTED
47340

Flex Adapter 7 Blade to 4 Flat

- Provides for a flexible reach
- Includes function testing LEDs
- Easy-pull grip design
- Dust cover and protected wire for added durability



PATENTED
47320

Flex Adapter 6 Round to 4 Flat

- Provides for a flexible reach
- Includes function testing LEDs
- Easy-pull grip design
- Dust cover and protected wire for added durability

VEHICLE SIDE CONNECTORS



PATENTED
48470

Multi-Tow® 7 Blade, 5 & 4 Flat

- Includes mounting bracket, screws and terminal grease
- Multiple connector options
- Durable lid opens 180°



PATENTED
48480

7 Blade

- Includes mounting bracket, screws and terminal grease
- Durable lid opens 180°



PATENTED
40950

Multi-Tow® 7 Blade & 4 Flat O.E.M. Replacement

- Compatible with Ford, GM and other popular tow vehicles.
- Multiple connector options
(See p. 52 Guide A for full listing)



PATENTED
40940

7 Blade O.E.M. Replacement

- Compatible with Ford, GM and other popular tow vehicles.
- Plug-In Simple!® for easy installation or replacement
(See p. 52 Guide A for full listing)



40930

7 Blade GM Twist Mount

- Compatible with Chev / GM
- Plug-In Simple!® for easy installation or replacement
(See p. 53 Guide C for full listing)



PATENTED
42190

Dodge/Chrysler/Jeep O.E.M. Quick-Install™ Wiring Kit

- Allows for Dodge trucks to adapt to the Quick-Install™ 7 Blade
- Plug-In Simple!® for easy installation or replacement
(See p. 53 Guide B for full listing)



PATENTED
47180 NEW 2016

Multi-Tow® 4 Flat to 7 Blade and 4 Flat Wiring Kit

- Allows existing 4 flat to adapt to multiple connector options
- Designed to retrofit existing mountings, including "in bumper" mounts



PATENTED
47200

4 Flat to 7 Blade Quick-Install™ Wiring Kit

- Allows existing 4 flat to adapt to the Quick-Install™ 7 Blade
- Quick and easy installation or replacement



PATENTED
47210

Universal Quick-Install™ Wiring Kit

- Pre-wired universal connection allows for flexibility in installation
- Reinforced lid opens 180° to prevent breaking



TRAILER SIDE CONNECTORS



PATENTED
48510

7 Blade (Metal)

- Includes mounting bracket, screws and terminal grease
- Ergonomic grip for easier handling
- Heavy-duty die-cast zinc housing



PATENTED
48500

7 Blade (Plastic)

- Includes mounting bracket, screws and terminal grease
- Ergonomic grip for easier handling



PATENTED
48440

6 Round

- Includes mounting bracket, screws and terminal grease
- Ergonomic grip for easier handling
- Heavy-duty die-cast zinc housing



PATENTED
47890

5 Flat Set

- 48 inch tow vehicle end socket and 18 inch trailer end plug
- Includes ground screw and terminal grease



PATENTED
47910

5 Flat

- Length, 18 inches
- Includes terminal grease
- Ergonomic grip for easier handling

Flex-Coil™

47065 - 7 Blade to 4 Flat (3 feet)

47083 - 7 Blade to 6 Round (center pin auxiliary) (3 feet)

47085 - 7 Blade to 6 Round (center pin electric brake) (3 feet)



[Shown 47065]

- Keeps wires from dangling on the ground preventing damages or shorts
- Stretches for greater flexibility
- Easy-grip, heavy-duty connectors with heavy-duty cable

Flex-Coil™ Adapters with Nite-Glow™

47053 - 7 Blade to 6 Round (8 feet)

47015 - 7 Blade to 4 Flat (3 feet)

47075 - 7 Blade to 5 Flat (3 feet)

47043 - 7 Blade to 4 Round (8 feet)

47055 - 6 Round to 6 Round (8 feet)

47045 - 4 Round to 4 Round (8 feet)

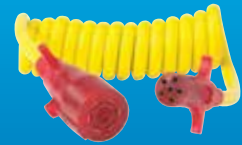

[Shown 47053]

- Nite-Glow™ illuminates on taillight function verifying continuity
- Stretches for greater flexibility
- Easy-grip, heavy-duty connectors with heavy-duty cable



PATENTED

40920

Multi-Tow® 7 Blade & 4 Flat GM Twist Mount

- Compatible with Chev / GM
 - Plug-In Simple!® for easy installation or replacement
- (See p. 53 Guide C for full listing)



48430

6 Round (Metal)

- Durable lid opens 180°
- Heavy-duty die-cast zinc housing



PATENTED

47900

5 Flat

- Length, 48 inches
- Ergonomic grip for easier handling



PATENTED

48030

4 Flat

- Length, 48 inches
- Ergonomic grip for easier handling



PATENTED

48190

Quick-Fix™ 4 Flat

- LED test lights confirm electrical continuity
- Ergonomic grip for easier handling

ENDURANCE™
PROFESSIONAL GRADE

BUILT TO LAST

PATENTED

5TH WHEEL WIRING KITS

40147 - FORD (Special order only)

40157 - FORD (Special order only)

40167 - FORD (Special order only)

40177 - FORD (Special order only)

42137 - DODGE

43397 - TOYOTA (Special order only)

41157 - CHEVY/GMC/FORD/DODGE/NISSAN/TOYOTA/RAM



(SEE PAGE 85 FOR FULL LISTING)

- **Plug-In Simple!®**
Reinforced 90° angle installs easily in hard to reach places
- **Plugs directly into O.E.M. wiring system**
Available for most full-size trucks
- **Maximum Durability and Performance**
Each kit includes a 7 blade connector and protected wires



PATENTED

48240

4 Flat Y-Harness 20 Feet

- Includes terminal grease, ground screw and trailer end dust cover
- Ergonomic grip for easier handling



PATENTED

48110

4 Flat

- Length, 12 inches
- Includes terminal grease and dust cover
- Ergonomic grip for easier handling



PATENTED

48192

Quick-Fix™ 4 Flat

- LED test lights confirm electrical continuity
- Ergonomic grip for easier handling

ENDURANCE™
QUICK-FIX™

INSTALLATION OR REPAIR AS EASY AS 1, 2, 3...

SCAN HERE TO SEE IT IN ACTION



DON'T REWIRE. ADAPT.

Hopkins® Plug-In Simple!® adapters prevent the need to rewire a vehicle or trailer when the connector styles do not match. Simply plug-in and start towing!

THE HOPKINS® ADVANTAGE

ENDURANCE™

Maximum durability and protection with industry's best 3-year warranty

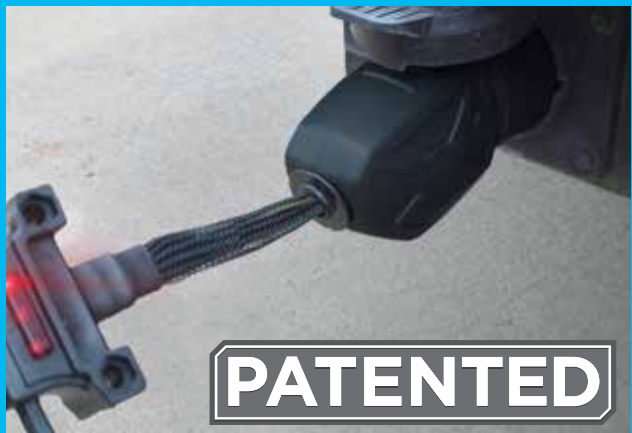

MULTI-TOW®

Multiple towing options from one vehicle-end connector



ADAPTERS



VALUE ADDED SELLING

This QR code accesses a mobile drop-down guide that helps consumers select the correct Plug-In Simple![®] adapter.

TO SEE IT
IN ACTION
SCAN HERE



LED TEST

Built in troubleshooting to verify electrical continuity



PATENTED

NITE-GLOW[™]

Illuminates upon activation of taillight to verify electrical continuity



PATENTED

ADAPTER SELECTION CHART

Find the vehicle side connector below, then match it with the trailer side connector. For added value and consumer benefits, look for adapter options with Endurance™, LED Test, Multi-Tow® and Nite-Glow™ features.

| | Vehicle Side | Trailer Side | Description | BEST | | BETTER | | GOOD | |
|---------|---|---|---|------------------------------|----------------|--|-----------------------|----------------------------------|-------|
| | | | | Endurance™ | LED-Test | Multi-Tow® | Nite-Glow™ | Basic | |
| 7 BLADE |  |  | 7 Blade to 4 Flat <small>p. 13</small> | 47015, 47065 47340, 47570 | 47345 47340 | 47385, 47565, 47570 47575, 47585, 47675 | 47015, 47335 47585 | 47355 47365 | |
| | | | 7 Blade to 5 Flat <small>p. 14</small> | 47075 47390 | 47390 | 47385, 47570 47675 | 47075 | 47375 | |
| | |  | 7 Blade to 6 Round <small>p. 15</small> | 47083 47085 | 47525 47535 | 47565, 47570 47575, 47585 | 47585 | 47545 47555 | |
| | | | 7 Blade to 6 Round <small>p. 16</small> | 47053 | | | 47053 | | |
| | |  | 7 Blade to 12-Volt <small>p. 16</small> | | | 47675 | | | |
| | | | 7 Blade to 7 Pin <small>p. 16</small> | | | | | 47595 | |
| | |  | 7 Blade to 4 Round <small>p. 16</small> | 47043 | | | 47043 | | |
| | | | 7 Blade to 7 Blade <small>p. 16</small> | 20049 | | | | | |
| 7 ROUND |  |  | 7 Round to 4 Flat <small>p. 17</small> | | | | | 47405 47407 | |
| | | | 7 Round to 6 Round <small>p. 17</small> | | | | | 47445 | |
| | | 7 Round to 7 Blade <small>p. 17</small> | | | | | | 47425 | |
| 6 ROUND |  |  | 6 Round to 4 Flat <small>p. 17</small> | 47320 | 47325 47320 | | | 47305 47315 | |
| | | | 6 Round to 6 Round <small>p. 18</small> | 47055 | | | 47055 | | |
| | |  | 6 Round to 7 Blade <small>p. 18</small> | | | | | | 47435 |
| | | | 6 Round to 6 Square <small>p. 18</small> | | | | | | 47415 |
| 4 FLAT |  |  | 4 Flat to 4 Flat <small>p. 19</small> | | 48143 | | | 47105 47115 48145 48235 | |
| | | | 4 Flat to 5 Flat <small>p. 19</small> | | | | | 47515 | |
| 4 ROUND |  |  | 4 Round to 4 Round <small>p. 18</small> | 47045 | | | 47045 | | |
| | | | 4 Round to 4 Flat <small>p. 18</small> | | | | | 47465 | |

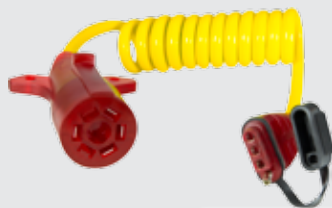

47015
Endurance™ Flex-Coil™ 7 Blade to 4 Flat with Nite-Glow™

- Nite-Glow™ illuminates on taillight function verifying continuity
- Stretches to 3 feet
- Easy-grip, heavy-duty connectors with heavy-duty cable



47065
Endurance™ Flex-Coil™ 7 Blade to 4 Flat

- Keeps wires from dangling on the ground preventing damages or shorts
- Stretches to 3 feet
- Easy-grip, heavy-duty connectors with heavy-duty cable



47570
Endurance™ Multi-Tow® 7 Blade to 6 Round, 5 and 4 Flat

- Patented Quick-Change™ plug quickly accommodates both 6 Round wiring codes
- Provides four towing options from a single device
- Overbuilt hinge, lid and connector housings provide maximum durability



47340
Endurance™ Flex Adapter 7 Blade to 4 Flat

- Provides a flexible reach
- Includes function testing LEDs
- Easy-pull grip design
- Dust cover and protected wire for added durability



47585
Multi-Tow® 7 Blade to 6 Round and 4 Flat with Nite-Glow™ (center pin auxiliary)

- Nite-Glow™ illuminates on taillight function and verifies electrical continuity
- Provides multiple towing options from one connector
- Universal center pin can be switched to auxiliary or electric brake trailer wiring codes



Multi-Tow® 7 Blade to 6 Round and 4 Flat

47565 (center pin auxiliary) / **47565B** (Bulk, 20 pk)
47575 (center pin electric brake) / **47575B** (Bulk, 20 pk)

- Provides multiple towing options from one connector
- Switchable center pin for use on trailers with varying wiring codes



47385 / 47385B (Bulk, 20 pk)
Multi-Tow® 7 Blade to 5 and 4 Flat

- Provides multiple towing options from one connector
- Includes dust covers for protection



47675
Multi-Tow® 7 Blade to 5 and 4 Flat

- Provides multiple towing options from one connector
- Turns your 7 Blade connector into a 12-Volt power socket



7 Blade to 4 Flat
47335

- Nite-Glow™ illuminates on taillight function verifying continuity
- Find your connection in the dark
- Includes dust cover

47355 / 47355B (Bulk, 20 pk)

- Includes dust cover



47345 / 47345B (Bulk, 20 pk)
7 Blade to 4 Flat LED Test

- Includes function testing LEDs
- Includes dust cover



47365 / 47365B (Bulk, 20 pk)
7 Blade to 4 Flat

- Includes dust cover
- Provides a flexible reach

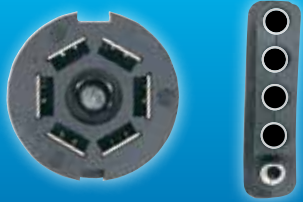

7 Blade to 5 Flat



47570
Endurance™ Multi-Tow®
7 Blade to 6 Round, 5 and 4 Flat

- Patented Quick-Change™ Plug
- Provides four towing options from a single device
- Overbuilt hinge, lid and connector housings provide maximum durability

QUICK-CHANGE™ PLUG



Patented Quick-Change™ plug easily allows the consumer to accommodate both 6 round wiring codes. Simply unplug, twist and plug back in.

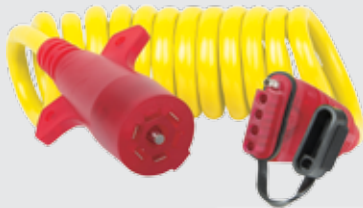

47075
Endurance™ Flex-Coil™
7 Blade to 5 Flat with Nite-Glow™

- Keeps wires from dangling on the ground preventing damages or shorts
- Nite-Glow™ illuminates on taillight function
- Stretches to 3 feet
- Heavy-duty connectors with heavy-duty cable



47390
Endurance™ Flex Adapter
7 Blade to 5 Flat

- Provides a flexible reach
- Includes function testing LEDs
- Easy-pull grip design
- Dust cover and protected wire for added durability



47675
Multi-Tow®
7 Blade to 5 and 4 Flat

- Provides multiple towing options from one connector
- Turns your 7 Blade connector into a 12-Volt power socket



47385 / 47385B (Bulk, 20 pk)
Multi-Tow®
7 Blade to 5 and 4 Flat

- Provides multiple towing options from one connector
- Includes dust covers for protection



47375 / 47375B (Bulk, 20 pk)
7 Blade to 5 Flat

- For use with marine trailers equipped with surge brakes
- Includes dust cover

QUICK, EASY TROUBLESHOOTING

The LED series incorporates built-in troubleshooting. If the trailer lights aren't working but the lights on the adapter are functioning, it's a trailer-side problem. If the adapter lights are not working, the problem is with the vehicle.





7 Blade to 6 Round



47083 Endurance™ Flex-Coil™ 7 Blade to 6 Round

(center pin auxiliary)

- Keeps wires from dangling on the ground preventing damages or shorts
- Stretches to 3 feet
- Easy-grip, heavy-duty connectors with heavy-duty cable



47085 Endurance™ Flex-Coil™ 7 Blade to 6 Round

(center pin electric brake)

- Keeps wires from dangling on the ground preventing damages or shorts
- Stretches to 3 feet
- Easy-grip, heavy-duty connectors with heavy-duty cable



47570 Endurance™ Multi-Tow® 7 Blade to 6 Round, 5 and 4 Flat

- Patented Quick-Change™ plug quickly accommodates both 6 Round wiring codes
- Provides four towing options from a single device
- Overbuilt hinge, lid and connector housings provide maximum durability



47585 Multi-Tow® 7 Blade to 6 Round and 4 Flat with Nite-Glow™

(center pin auxiliary)

- Nite-Glow™ illuminates on taillight function and verifies electrical continuity
- Provides multiple towing options from one connector
- Universal center pin can be switched to auxiliary or electric brake trailer wiring codes



47565/ 47565B (Bulk, 20 pk) Multi-Tow® 7 Blade to 6 Round and 4 Flat

(center pin auxiliary)

- Provides multiple towing options from one connector
- Universal center pin can be switched to auxiliary or electric brake trailer wiring codes



47575 / 47575B (Bulk, 20 pk) Multi-Tow® 7 Blade to 6 Round and 4 Flat

(center pin electric brake)

- Provides multiple towing options from one connector
- Universal center pin can be switched to auxiliary or electric brake trailer wiring codes



47525 7 Blade to 6 Round LED Test

(center pin auxiliary)

- Built-in troubleshooting
- Function testing LEDs
- Universal center pin can be switched to auxiliary or electric brake trailer wiring codes
- Includes dust cover



47535 7 Blade to 6 Round LED Test

(center pin electric brake)

- Built-in troubleshooting
- Function testing LEDs
- Universal center pin can be switched to auxiliary or electric brake trailer wiring codes
- Includes dust cover



47545 / 47545B (Bulk, 20 pk) 7 Blade to 6 Round

(center pin auxiliary)

- Includes dust cover for protection
- Universal center pin can be switched to auxiliary or electric brake trailer wiring codes
- Easy-pull grip and corrosion resistant, tin-plated terminals



47555 / 47555B (Bulk, 20 pk) 7 Blade to 6 Round

(center pin electric brake)

- Includes dust cover for protection
- Universal center pin can be switched to auxiliary or electric brake trailer wiring codes
- Easy-pull grip and corrosion resistant, tin-plated terminals

HOPKINS® EXCLUSIVE



Trailers with 6 Round connectors are wired in two different ways. Only Hopkins® offers a switchable center pin, satisfying consumer needs and preventing returns. See page 122 for more information



7 Blade Specialties



20049

PATENTED

ENDURANCE
PROFESSIONAL GRADE

Endurance™ 7 Blade to 7 Blade

- Extends the reach of the gooseneck or 5th
- Wheel connector to the back of the tow vehicle
- Length, 8 feet
- Heavy-duty connectors and cable



47054

ENDURANCE
PROFESSIONAL GRADE

Endurance™ Flex-Coil™ 7 Blade to 6 Round with Nite-Glow™ Kit (center pin electric brake)

- Nite-Glow™ illuminates on taillight function verifying continuity
- Stretches to 8 feet
- Easy-grip, heavy-duty connectors with heavy-duty cable



47053

ENDURANCE
PROFESSIONAL GRADE

Endurance™ Flex-Coil™ 7 Blade to 6 Round with Nite-Glow™ (center pin electric brake)

- Nite-Glow™ illuminates on taillight function verifying continuity
- Stretches to 8 feet
- Easy-grip, heavy-duty connectors with heavy-duty cable

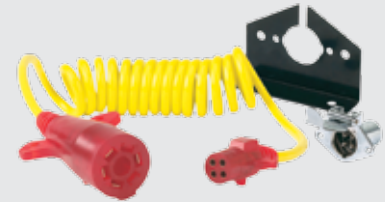

47044

ENDURANCE
PROFESSIONAL GRADE

Endurance™ Flex-Coil™ 7 Blade to 4 Round with Nite-Glow™ Kit

- Nite-Glow™ illuminates on taillight function verifying continuity
- Stretches to 8 feet
- Easy-grip, heavy-duty connectors with heavy-duty cable



47043

ENDURANCE
PROFESSIONAL GRADE

Endurance™ Flex-Coil™ 7 Blade to 4 Round with Nite-Glow™

- Nite-Glow™ illuminates on taillight function verifying continuity
- Stretches to 8 feet
- Easy-grip, heavy-duty connectors with heavy-duty cable



47057

Straight Wire 7 Blade to 6 Round Kit

(6 Round center pin electric brake)

- Length, 8 feet
- Easy-grip, heavy-duty connectors with heavy-duty cable

(Special order only)



47047

Straight Wire 7 Blade to 4 Round Kit

- Length, 8 feet
- Easy-grip, heavy-duty connectors with heavy-duty cable

(Special order only)



47595

7 Blade to 7 Round

- Die-cast zinc for durability (7 Round)
- Provides a flexible reach



BACK VIEW

47675

Multi-Tow® 7 Blade to 5 and 4 Flat with 12-Volt

PATENTED

- Provides multiple towing options from one connector
- Turns your 7 Blade connector into a 12-Volt power socket
- Weatherproof connector lids and tin-plated terminals prevent corrosion



47407
7 Round to 4 Flat

- Built-in taillight converter for vehicles with independent brake and turn signals
- Easy pull grip
- Provides a flexible reach



47405 / 47405B (Bulk, 20 pk)
7 Round to 4 Flat

- Includes dust cover
- Easy-pull grip design



47445
7 Round to 6 Round (6 Round center pin auxiliary)

- Includes dust cover
- Easy-pull grip design



47425
7 Round to 7 Blade

- Protective convoluted wire tubing
- Provides a flexible reach

ENDURANCE™
PROFESSIONAL GRADE

For maximum durability and protection, use an Endurance™ adapter.

Endurance™ adapters come packed with advanced features and the industry's best 3-year warranty.

See page 8 for full offering



47320
Endurance™ Flex Adapter 6 Round to 4 Flat

- Provides a flexible reach
- Includes function testing LEDs
- Easy-pull grip design
- Dust cover and protected wire for added durability



47325
6 Round to 4 Flat LED Test

- Includes function testing LEDs
- Includes dust cover



47315
6 Round to 4 Flat

- Die-cast zinc for durability (6 Round)
- Provides a flexible reach
- Includes dust cover



47305/ 47305B (Bulk, 20 pk)
6 Round to 4 Flat

- Includes dust cover
- Easy-pull grip design



6 Round Specialties



47055

Endurance™ Flex-Coil™ 6 Round to 6 Round with Nite-Glow™

- Nite-Glow™ illuminates on taillight function verifying continuity
- Stretches to 8 feet
- Heavy-duty cable



47056

Endurance™ Flex-Coil™ 6 Round to 6 Round with Nite-Glow™ Kit

- Nite-Glow™ illuminates on taillight function verifying continuity
- Stretches to 8 feet
- Heavy-duty cable with matching connectors and mounting brackets



47415

6 Round to 6 Square (center pin electric brake)

- Die-cast zinc for durability (6 Round)
- Provides a flexible reach



47435 / 47435B (Bulk, 20 pk)

6 Round to 7 Blade (center pin electric brake)

- Die-cast zinc for durability (6 Round)
- Provides a flexible reach

FACT:

Hopkins® has the largest offering of adapters in the industry



4 Round Specialties



47045

Endurance™ Flex-Coil™ 4 Round to 4 Round with Nite-Glow™

- Nite-Glow™ illuminates on taillight function verifying continuity
- Stretches to 8 feet
- Heavy-duty cable

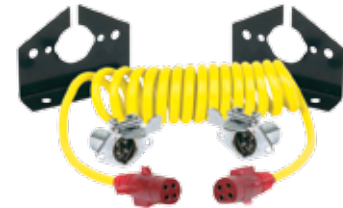

47046

Endurance™ Flex-Coil™ 4 Round to 4 Round with Nite-Glow™ Kit

- Nite-Glow™ illuminates on taillight function verifying continuity
- Stretches to 8 feet
- Heavy-duty cable with matching connectors and mounting brackets



47465

4 Round to 4 Flat

- Die-cast zinc for durability (4 Round)
- Provides a flexible reach

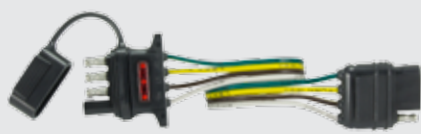
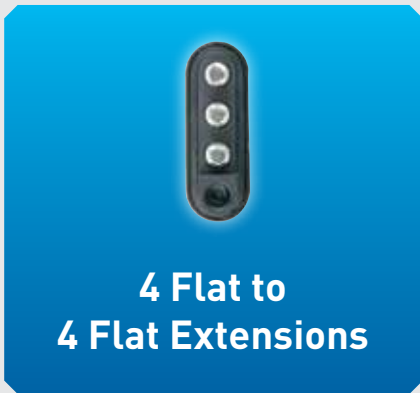

48143 NEW 2016
LED Test 4 Flat Extension

- Includes function testing LEDs
- Length, 12 inches



48235
4 Flat Extension

- Extends wiring system for more flexibility
- Length, 10 feet



47115 / 47115B (Bulk, 20 pk)
4 Flat Extension

- Extends wiring system for more flexibility
- Length, 48 inches



47105 / 47105B (Bulk, 20 pk)
4 Flat Extension

- Utilizes an exterior vehicle frame ground
- Length, 32 inches



48145
4 Flat Extension

- Extends wiring system for more flexibility
- Length, 12 inches



47515
4 Flat to 5 Flat

- For use with marine trailers equipped with surge brakes
- Bullet terminal and splice connector included
- Retrofits existing 4 Flat to a 5 Flat

BACK VIEW



47605
4 Flat Knockout

- For use with 1.25 inch diameter hole or bracket #48605
- Dust cover included

BACK VIEW

MARKET LEADING INNOVATIONS.

The brake control market has been stagnant for decades ... not anymore! We listened to the consumer and developed new and innovative features to meet their needs.

- Intuitive vertical manual slide matches how consumers reach for the brake control
- Easy to understand 0-99% gain settings
- Each brake control is backed by a Lifetime Warranty
- More convenient installation

THE HOPKINS® ADVANTAGE

BEST RETAIL BRAND

Innovative feature sets at consumer friendly price points



CONTINUED INNOVATION

INSIGHT™ FLEX-MOUNT™ Brake Control installs with absolutely no tools required





BRAKE CONTROL EXCELLENCE

Part#: 47297

Product Name: InSIGHT™ Flex-Mount™ Brake Control



I had this installed on my 2009 Ford F150. It replaced another brake controller that was under my steering wheel that was very difficult to use. When I used my old brake control I had to take my eyes off the road to read it and it was even more distracting if I wanted to apply trailer brakes manually. The InSight controller is much safer because it has a readout near my line-of-sight, a manual control beside my steering wheel, and the power box is far enough under my dash that I never have to worry about banging my knees on it. As a trailer brake control upgrade, this is great. I have been very pleased to have it! - F. Weltha

PROVEN PERFORMANCE

Setting the highest standards for performance, control and ease of use



LIFETIME WARRANTY

Reinforcing consumer confidence, every brake control comes with a lifetime warranty



**LIFETIME
WARRANTY**

THE NEW GENERATION

BUILT FOR TODAY'S TRUCKS

Trucks continue to evolve to meet consumer needs. It's time for brake controls to do the same. The InSIGHT™ brake control solves the problem of inconvenient mounting, out-of-reach controls and difficult to see displays.



47297

InSIGHT™ FLEX-MOUNT™ Brake Control

LIFETIME WARRANTY

- **Flex-Mount™ Versatility**

Creates the perfect install for any vehicle

- **No-Tools-Required Installation**

Plug-In Simple!® components just plug in and start towing

- **Increased User Control**

Flexible installation brings manual controls within reach and helps keep eyes on the road

- **Advanced Proportional Technology**

Inertia activated braking mirrors the action of the towed vehicle, creating safe, smooth stops

- **Added Benefits**

- 7 sensitivity settings for advanced braking control
- Short proof protection for up to 8 trailer brakes























SCAN HERE
TO SEE IT IN ACTION
AND VISIT THE SITE

FLEX-MOUNT VERSATILITY



CONSUMER TESTED, CONSUMER APPROVED.

★★★★★ I have driven now almost 3000 miles with a Hopkins Agility Brake Control. The setup was easy and adjustment was simple. I would recommend this to anyone towing and needing a brake controller. I have used several other brake controllers and this one is superior. - N. CLAAR

| TRAILER BRAKE CONTROLS | | BRAKING CAPACITY | FLEXIBLE MOUNT™ VERSATILITY | NO TOOLS REQUIRED INSTALLATION | SENSITIVITY | ELECTRIC/HYDRAULIC | BRAKE FAILURE NOTIFICATION | TRAILER CONTINUITY | SHORT PROTECTION | LIFETIME WARRANTY |
|----------------------------|---|---|-----------------------------|--------------------------------|-------------|--------------------|----------------------------|--------------------|------------------|-------------------|
| PROPORTIONAL / PROGRESSIVE | InSIGHT™ 47297  |  2  4  6  8 | ● | ● | 7 | ● | ● | ● | ● | ● |
| | AGILITY™ 47294 47295 Without plug  |  2  4  6  8 | | | 5 | ● | ● | ● | ● | ● |
| TIME BASED | IMPULSE™ 47235  |  2  4  6 | | | | ● | ● | ● | ● | ● |
| | RELIANCE™ 47284 47285 Without plug  |  2  4 | | | | | ● | ● | ● | ● |
| | BRAKE-FORCE™ 47225  |  2  4 | | | | | | | ● | ● |

UNIVERSAL BRAKE CONTROL CONNECTORS

Make your brake control installation easy!
No more running wires through
the firewall or searching for
the stop switch.

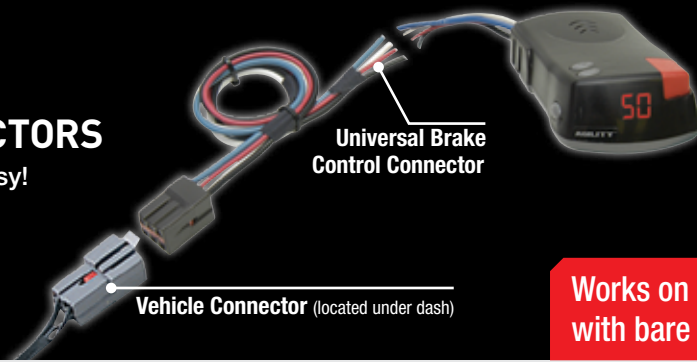

Works on brake controls
with bare wires



47625 NISSAN / INFINITI

| | |
|------------|---------|
| Armada | 2004-13 |
| Titan | 2004-13 |
| Frontier | 2004-13 |
| Pathfinder | 2004-13 |
| Xterra | 2004-08 |
| QX-56 | 2004-13 |
| NV Van | 2014 |



47695 FORD

| | |
|-----------------|---------|
| F-Series Pickup | 1992-93 |
| Bronco | 1992-93 |



47705 / 47705B (Bulk, 20 pk) FORD / MERCURY / LANDROVER / LINCOLN

| | | | |
|-----------------|---------|-------------|---------|
| Bronco | 1994-96 | Windstar | 1996-03 |
| F-150 | 1994-08 | Mountaineer | 2000-11 |
| F-250 / F-350 | 1994-04 | LR3 | 2005-10 |
| Expedition | 1997-11 | LR4 | 2010-11 |
| Van (full size) | 1994-98 | Range Rover | 2005-13 |
| Van (full size) | 2003-08 | Mark LT | 2007-08 |
| Excursion | 2000-05 | MKT | 2010-12 |
| Explorer | 2000-13 | Navigator | 1998-12 |
| Flex | 2009-11 | | |



47725 FORD

| | |
|---------------|---------|
| F-250 / F-350 | 2005-07 |
| F-450 / F-550 | 2005-07 |



47745 47745B (Bulk, 20 pk) DODGE / CHRYSLER

| | |
|-------------|---------|
| Dakota | 1997-11 |
| Durango | 1998-09 |
| Ram Pickups | 1995-09 |
| Aspen | 2007-09 |



47775 / 47775B (Bulk, 20 pk) CHEVY / GMC / CADILLAC / HUMMER

| | | | |
|---------------------|---------|----------|---------|
| Avalanche | 2002-06 | Tahoe | 2000-06 |
| Silverado | 1999-06 | Yukon | 2000-06 |
| Silverado (classic) | 2007 | Denali | 1999-06 |
| Sierra | 1999-06 | Escalade | 2000-06 |
| Sierra (classic) | 2007 | H2 | 2003-07 |
| Suburban | 2000-06 | H2 SUT | 2005-07 |



47805 TOYOTA / LEXUS

| | |
|--------------|---------|
| 4-Runner | 2003-11 |
| Land Cruiser | 2003-10 |
| Sequoia | 2003-13 |
| Tundra | 2003-12 |
| Tacoma | 2005-13 |
| GX 460 | 2010-13 |
| GX 470 | 2004-10 |
| LX 570 | 2008-13 |



47825 FORD / LINCOLN

| | |
|-------|---------|
| F-150 | 2009-15 |
| Flex | 2012-15 |
| MKT | 2012-13 |



47835 FORD / LINCOLN

| | | | |
|-------|---------|------------|---------|
| F-250 | 2008-15 | E-350 | 2009-13 |
| F-350 | 2008-15 | E-350 RV | 2009-11 |
| F-450 | 2008-15 | E-450 RV | 2009-11 |
| F-550 | 2008-15 | Expedition | 2013 |
| E-150 | 2009-13 | Navigator | 2013-14 |
| E-250 | 2009-13 | | |



47865 BUICK / CHEVY / GMC SATURN

| | |
|----------|---------|
| Enclave | 2008-15 |
| Traverse | 2009-14 |
| Acadia | 2007-14 |
| Outlook | 2007-09 |



47925 HONDA

| | |
|-----------|---------|
| Pilot | 2009-13 |
| Ridgeline | 2006-12 |



53025 DODGE / RAM

| | |
|------|---------|
| 1500 | 2010-12 |
| 2500 | 2010-12 |
| 3500 | 2010-12 |



53045 DODGE / JEEP

| | |
|------------------------|---------|
| Durango (w/tow) | 2011-12 |
| Grand Cherokee (w/tow) | 2011-12 |



53065 DODGE / RAM

| | |
|------|---------|
| 1500 | 2013-14 |
|------|---------|



53057 **NEW 2016** RAM

| | |
|------|------|
| 1500 | 2015 |
| 2500 | 2015 |
| 3500 | 2015 |



53085 CHEVY / GMC

| | |
|-----------|---------|
| Silverado | 2014-15 |
| Sierra | 2014-15 |



47275 (wiring info - p 123) UNIVERSAL BRAKE CONTROL KIT

(For vehicles w/o tow pkg)
Everything needed to install
brake controls

- 10 Zip Ties, 4 Butt Splices, 3' Red Wire (16 Gauge), 1 Splice Connector, 1 Ring Connector, 15' Black Wire (12 Gauge), 1 - 20' Amp Fuse/Holder, 15' White wire (12 Gauge), 25' Blue wire (12 Gauge)

PLUG-IN SIMPLE![®] BRAKE CONTROL CONNECTORS

Many of today's tow vehicles come equipped with trailer tow packages. Tow packages include an O.E.M. brake control harness, found under the dashboard, that makes brake control installations much easier.

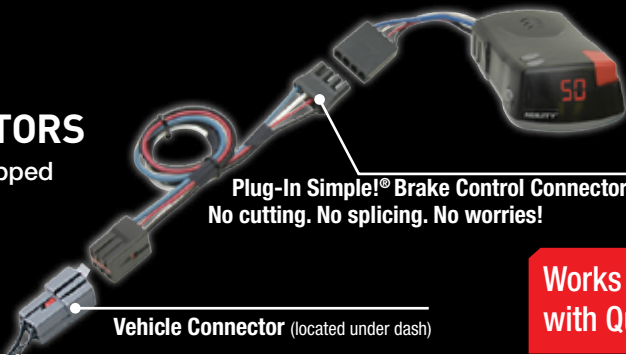

Plug-In Simple![®] Brake Control Connectors
No cutting. No splicing. No worries!



Works on brake controls
with Quick-Connect plug

Vehicle Connector (located under dash)



47635 NISSAN / INFINITI

| | |
|------------|---------|
| Armada | 2004-13 |
| Titan | 2004-13 |
| Frontier | 2004-13 |
| Pathfinder | 2004-13 |
| Xterra | 2004-08 |
| QX-56 | 2004-13 |
| NV Van | 2014 |



47715 FORD / MERCURY / LANDROVER / LINCOLN

| | | | |
|-----------------|---------|-------------|---------|
| Bronco | 1994-96 | Windstar | 1996-03 |
| F-150 | 1994-08 | Mountaineer | 2000-11 |
| F-250 / F-350 | 1994-04 | LR3 | 2005-10 |
| Expedition | 1997-11 | LR4 | 2010-11 |
| Van (full size) | 1994-98 | Range Rover | 2005-13 |
| Van (full size) | 2003-08 | Mark LT | 2007-08 |
| Excursion | 2000-05 | MKT | 2010-12 |
| Explorer | 2000-13 | Navigator | 1998-12 |
| Flex | 2009-11 | | |



47735 FORD

| | |
|---------------|---------|
| F-250 / F-350 | 2005-07 |
| F-450 / F-550 | 2005-07 |



47755 DODGE / CHRYSLER

| | |
|-------------|---------|
| Dakota | 1997-11 |
| Durango | 1998-09 |
| Ram Pickups | 1995-09 |
| Aspen | 2007-09 |



47795 CHEVY / GMC / CADILLAC / HUMMER

| | | | |
|---------------------|---------|----------|---------|
| Avalanche | 2002-06 | Tahoe | 2000-06 |
| Silverado | 1999-06 | Yukon | 2000-06 |
| Silverado (classic) | 2007 | Denali | 1999-06 |
| Sierra | 1999-06 | Escalade | 2000-06 |
| Sierra (classic) | 2007 | H2 | 2003-07 |
| Suburban | 2000-06 | H2 SUT | 2005-07 |



47815 TOYOTA / LEXUS

| | |
|--------------|---------|
| 4-Runner | 2003-11 |
| Land Cruiser | 2003-10 |
| Sequoia | 2003-13 |
| Tundra | 2003-12 |
| Tacoma | 2005-13 |
| GX 460 | 2010-13 |
| GX 470 | 2004-10 |
| LX 570 | 2008-13 |



47845 FORD / LINCOLN

| | |
|-------|---------|
| F-150 | 2009-15 |
| Flex | 2012-15 |
| MKT | 2012-13 |

INCREASE SALES AND CONSUMER SATISFACTION

This QR code is on every brake control package and accesses a mobile drop-down guide. It helps the consumer select the correct brake control connector to fit their vehicle.

TO SEE IT
IN ACTION
SCAN HERE



47855 FORD / LINCOLN

| | | | |
|-------|---------|------------|---------|
| F-250 | 2008-15 | E-350 | 2009-13 |
| F-350 | 2008-15 | E-350 RV | 2009-11 |
| F-450 | 2008-15 | E-450 RV | 2009-11 |
| F-550 | 2008-15 | Expedition | 2013 |
| E-150 | 2009-13 | Navigator | 2013-14 |
| E-250 | 2009-13 | | |

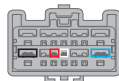

47875 BUICK / CHEVY / GMC SATURN

| | |
|----------|---------|
| Enclave | 2008-15 |
| Traverse | 2009-14 |
| Acadia | 2007-14 |
| Outlook | 2007-09 |



47935 HONDA

| | |
|-----------|---------|
| Pilot | 2009-13 |
| Ridgeline | 2006-12 |



53015 DODGE / RAM

| | |
|------|---------|
| 1500 | 2010-12 |
| 2500 | 2010-12 |
| 3500 | 2010-12 |



53035 DODGE / JEEP

| | |
|------------------------|---------|
| Durango (w/tow) | 2011-12 |
| Grand Cherokee (w/tow) | 2011-12 |



53055 DODGE / RAM

| | |
|------|---------|
| 1500 | 2013-14 |
|------|---------|



53056 NEW 2016 RAM

| | |
|------|------|
| 1500 | 2015 |
| 2500 | 2015 |
| 3500 | 2015 |



53075 CHEVY / GMC

| | |
|-----------|---------|
| Silverado | 2014-15 |
| Sierra | 2014-15 |



47685 CHEVY / GMC / UNIVERSAL

| | |
|-----------|---------|
| Avalanche | 2007-13 |
| Silverado | 2007-13 |
| Sierra | 2007-13 |
| Suburban | 2007-13 |
| Tahoe | 2007-13 |
| Denali | 2007-13 |
| Escalade | 2007-13 |
| H2 | 2008-09 |
| H2 SUT | 2008-09 |

INVESTMENT PROTECTION WITH THE ENGAGER.™

**TRAILER BREAK-AWAY KITS ARE LEGALLY
REQUIRED IN MOST STATES AND PROVINCES**

The ENGAGER™ Trailer Break-Away System changes the way consumers protect their trailer investment

- Activates trailer brakes upon separation from tow vehicle
- Built-in battery meter and charger with LED test lights
- LEDs indicate:
 - Fully charged
 - Re-charge
 - Charging
- 1 to 2 axle capacity
- 5 Amp hour battery

PATENTED



20099

PATENTED

ENGAGER™ Side-Mount Break-Away Kit

- Includes built-in battery meter and charger
- LEDs indicate battery charge status
- Switch wire - Length, 7 inches
- 3 mounting screws included



PATENTED

20400

PATENTED

ENGAGER™ Flip-Top Break-Away Kit

- Includes built-in battery meter and charger
- LEDs indicate battery charge status
- Switch wire - Length, 7 inches



20001

PATENTED

Traditional Break-Away Kit

- Jack stand or side mountable
- Includes battery charger
- Switch wire - Length, 7 inches
- 2 U-bolts, 4 mounting screws, nuts and washers included



BREAK-AWAY ACCESSORIES

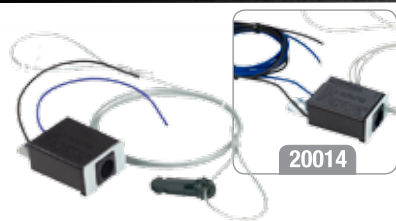

Break-Away Switch

20005 / 20010 (Bulk, No UPC)

- Durable pin and vehicle hook-up cable
- Weatherproof design
- Length, 7 inches

20014 (Bulk, No UPC)

- Length, 44 inches

PATENTED



LED Break-Away Switch

20050 / 20059 (Bulk, No UPC)

- LED verifies 12-Volt power is being transferred to the trailer brakes
- Durable pin and vehicle hook-up cable
- Weatherproof design
- Length, 7 inches

20060 (Bulk, No UPC)

- Length, 44 inches

PATENTED

WHY LED TEST?

A LED light, built into the break-away switch, illuminates upon removal of the plunger, verifying that power is passing through the switch



20052 / 20051 (Bulk, No UPC)

Replacement Cable & Pin

- Durable pin and vehicle hook-up cable



20007 / 20011 (Bulk, No UPC)

Break-Away Battery Charger

- Charges battery when vehicle and trailer are connected
- Installs conveniently inside break-away box
- Impact resistant plastic



20008

12-Volt Rechargeable Battery

- 5 Amp hour rated battery
- Exceed D.O.T. regulation 393.43 (d)
- Will hold trailer brakes on for at least 15 min. (1 to 2 axle)



20107

Weldable Mounting Plate

- For ENGAGER™ Side-Mount (3 hole) Break-Away Kits
- Eliminates the need to drill holes in trailer frame



20407

Weldable Mounting Plate

- For ENGAGER™ Flip-Top (4-6 hole) Break-Away Kits
- Eliminates the need to drill holes in trailer frame

GET EQUIPPED. STAY CONNECTED.

Trailer side connectors are electrical plugs attached to the front end of a trailer electrical harness. These connectors will consolidate all of the electrical towing functions of a trailer into a single plug for connecting to the vehicle side socket.



THE HOPKINS® ADVANTAGE

LARGEST SELECTION

7 Blade, 7 Round, 6 Round, 5 Flat, 5 Round
4 Flat, 4 Round and Sets



ENDURANCE™

Maximum durability and weather protection
with industry's best 3-year warranty



TRAILER SIDE



LED TEST CONNECTORS

Built-in troubleshooting that verifies electrical functions

NEW 2016



CONSUMER SATISFACTION







Ease of use through printed wire functions, tin plated terminals and easy to grip connectors



TRAILER SIDE CONNECTORS SELECTION CHART

Find the style of trailer side connector you are looking for with the part numbers listed. For added value and consumer benefits look for the connector options with Endurance™, LED test and Nite-Glow™ features.



| Trailer Side | Description | BEST | | BETTER | GOOD |
|---|------------------|-------------------------|------------------------------|----------------|--|
| | | Endurance™ | LED Test | Nite-Glow™ | Basic |
|  | 7 Blade p. 31 | 48500 48510 | 20086, 20087 20286, 48503 | 48502 | 20042, 20043, 20044 20045, 20047, 20048 20146, 20244, 20245 20246, 20248, 48465 48505, 48515 |
|  | 7 Round p. 31 | | | | 52024 52027 |
|  | 6 Round p. 32 | 48440 | | | 20033, 20034, 20036 20136, 48405, 48445 52007, 52008 |
|  | 5 Flat p. 32 | 47890, 47910 | 47913 | | 47895 47915 |
|  | 5 Round p. 32 | | | | 48345 48385 |
|  | 4 Round p. 33 | | | | 48285, 48295 48325, 52006 |
|  | 4 Flat p. 33 | 48110 48192 48240 | 48133 | | 48105, 48115, 48125 48135, 48165, 48175 48195, 48205, 48215 48245, 48255, 48265 |
| Specialty Connectors | | | | | |
| 12-Volt | 1 Pole Round | 2 Pole Flat | 2 Pole In-Line | 4 Pole In-Line | Square Sets |
| 55110, 55115, 55120, 55125 p. 39 | 52002 p. 39 | 47965 p. 39 | 47945 p. 39 | 47955 p. 39 | 47975, 47985, 47995 p. 35 |



7 Blade

7 Blade connectors are typically used with large trailers (RV and industrial). These connectors provide the following functions: left/right turn, taillight, ground, auxiliary, electric brake, backup/reverse



48510

PATENTED ENDURANCE PROFESSIONAL GRADE

Endurance™ 7 Blade (Metal)

- Includes mounting bracket, screws and terminal grease
- Ergonomic grip for easier handling
- Heavy-duty die-cast zinc housing



48500

PATENTED ENDURANCE PROFESSIONAL GRADE

Endurance™ 7 Blade (Plastic)

- Includes mounting bracket, screws and terminal grease
- Ergonomic grip for easier handling



NEW 2016

LED Test 7 Blade Molded Cable

20286

20086 (Bulk, 6 feet)

20087 (Bulk, 8 feet)

- Quick/ Easy troubleshooting
- LEDs verify electrical functions

PATENT PENDING



NEW 2016

SAE Code 7 Blade Molded Cable

20245

20045 (Bulk)

- 2- 10 gauge; 1- 12 gauge; 4-14 gauge wires
- Length, 6 feet



RV Code 7 Blade Molded Cable

2-10 gauge; 1-12 gauge; 4-14 gauge

(Bulk, 5 pk)

20042 (Length, 3 feet) / 20043 (Length, 4 feet)

20044 (Length, 6 feet) / 20047 (Length, 8 feet)

20048 (Length, 11 feet)

Packaging

20244 (Length, 6 feet) / 20246 (Length, 8 feet)

20248 (Length, 11 feet) / 20146 (Length, 8 feet) (UPC ONLY)



48503

LED Test 7 Blade

- Quick/Easy troubleshooting
- LEDs verify electrical functions

PATENT PENDING



48502 **NEW 2016**

Nite-Glow™ 7 Blade (Plastic)

- Illuminates on taillight function verifying continuity



48515

7 Blade (Metal)

- Aluminum housing



7 Blade (Plastic)

48505

48505B (Bulk, 20 pk) / 38508 (Bulk, 100 pk)

- Easy-pull grip design



7 Round

7 Round connectors are typically used with larger farming or commercial fleet trailers. These connectors provide the following functions: left/right turn, taillight, ground, auxiliary, electric brake, backup/reverse



52024

7 Round (Metal)

- Heavy-duty die-cast zinc housing



52027
Heavy Duty 7-Round (Metal)

- Includes cable protector
- Heavy-duty die-cast zinc housing



6 Round

6 Pole connectors are typically used with horse trailers or utility/cargo trailers equipped with electric brakes. These connectors provide the following functions: left/right turn, taillight, ground, auxiliary, electric brake



48440
Endurance™ 6 Round



- Includes mounting bracket, screws and terminal grease
- Ergonomic grip for easier handling
- Heavy-duty die-cast zinc housing



6 Round (Metal)
48445

48445B (Bulk, 20pk) / **38448** (Bulk, 100 pk)

- Heavy-duty die-cast zinc housing



Heavy Duty 6 Round (Metal)
52008

- Includes cable protector
- Heavy-duty die-cast zinc housing



6 Round Jacketed Cable (Center pin electric brake)
 (Bulk only) (6-14 Gauge wires)

- 20033** - Length, 4 feet
- 20034** - Length, 6 feet
- 20036** - Length, 8 feet
- 20136** - Length, 8 feet (UPC only)



5 Flat

5 Flat connectors are typically used with marine applications. These connectors provide the following functions: left/right turn, taillight, ground and surge brake release



47910
Endurance™ 5 Flat



- Includes terminal grease and dust cover to protect terminals
- Ergonomic grip for easier handling
- Length, 18 inches



47913
LED Test 5 Flat

- Quick/Easy troubleshooting
- LEDs verify electrical functions
- Easy-pull grip
- Length, 24 inches



47915
5 Flat

- Length, 18 inches



5 Round

Die-cast connectors provide durability. These connectors provide the following functions: left/right turn, taillight, ground and either surge brake release, auxiliary or electric brake



48385
5 Round (Metal)

- Die-cast zinc housing



4 Round

Die-cast connectors provide durability. These connectors provide the following functions: left/right turn, taillight and ground



52006 Heavy-Duty 4 Round (Metal)

- Heavy-duty die-cast zinc housing



48325 4 Round (Metal)

- Die-cast zinc housing



4 Flat

4 Flats are the most commonly used trailer plug. This plug is found on small boats, utility, jet skis, snowmobiles and small camper trailers where right turn/brake, left turn/brake, tail/marker lights and ground is needed



48192 Endurance™ Quick-Fix™ 4 Flat

- LEDs verify electrical functions
- Includes terminal grease and dust cover to protect terminals
- Repairs/replaces damaged 4 Flat



48110 Endurance™ 4 Flat

- Includes terminal grease and dust cover to protect terminals
- Ergonomic grip for easier handling
- Length, 12 inches

TEST & CONFIRM BEFORE YOU TOW



TO SEE IT IN
ACTION SCAN HERE



48133 LED Test 4 Flat

- Quick/Easy troubleshooting
- LEDs verify electrical functions
- Easy-pull grip
- Length, 24 inches



48105 4 Flat

- 3 splices included
- Length, 12 inches



4 Flat 48115 48115B (Bulk, 20 pk) / 38118 (Bulk, 200 pk)

- Length, 12 inches

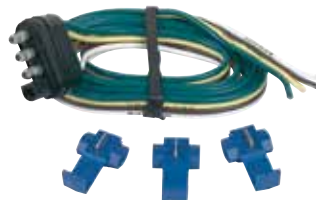

4 Flat 48125

- Length, 48 inches
- 3 splices included



4 Flat 48135 48135B (Bulk, 20 pk) / 38138 (Bulk, 200 pk)

- Length, 48 inches

THE SOLUTION FOR TRAILER REWIRING.

4 Flats are the most commonly used trailer plug. This plug is found on small boat, utility, jet ski, snowmobile and small camper trailers where right turn/brake, left turn/brake, tail/marker lights and ground are needed.

4 Flat Y-Harness

- Eliminates Unnecessary Splicing
- Complete Weather Protection from Connector to Taillights
- Meets or Exceeds SAE Standards

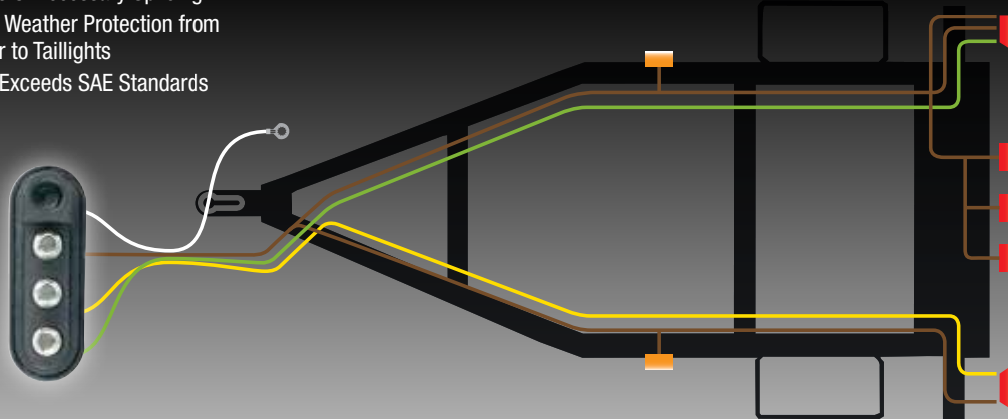

*See wiring guide on page 122



48240 PATENTED **ENDURANCE**
PROFESSIONAL GRADE
Endurance™ 4 Flat Y-Harness

- Includes terminal grease, ground screw and trailer end dust cover
- Ergonomic grip for easier handling
- Length, 20 feet



48245
4 Flat Y-Harness

- Length, 20 feet



48255 / 48255B (Bulk, 20 pk)
4 Flat Y-Harness

- Length, 25 feet



48265
4 Flat Y-Harness

- Length, 30 feet

Connector Sets

All sets contain matching vehicle and trailer end connectors



48465
7 Blade Kit

- Tow vehicle end plastic socket and trailer end plastic plug
- Includes mounting bracket and hardware



48405
6 Round Kit

- Tow vehicle end plastic socket and trailer end metal plug
- Includes mounting bracket, wire, splices and hardware



CONNECTOR SETS *(Continued)*



47890 PATENTED **ENDURANCE**
Endurance™ 5 Flat Set

- 48 inch tow vehicle end
- 18 inch trailer end
- Includes ground screw and terminal grease



52007
6 Round Set

- Tow vehicle end metal socket and trailer end metal plug
- Cable protector included



47895
5 Flat Set

- 48 inch tow vehicle end
- 18 inch trailer end



48345
5 Round Kit

- Tow vehicle end metal socket and trailer end metal plug
- Includes mounting bracket, wire, splices and hardware



48205
4 Flat Set

- 48 inch tow vehicle end
- 12 inch trailer end
- Includes 6 splice connectors



48215
4 Flat Set

- 48 inch tow vehicle end
- 12 inch trailer end



48165
4 Flat Set

- 12 inch tow vehicle end socket
- 12 inch trailer end
- Includes 6 splice connectors



48175
4 Flat Set

- 12 inch tow vehicle end
- 12 inch trailer end



48195 PATENTED
20031 (Bulk, 50 pk, trailer side only)
Quick-Fix™ Flat Set

- Contains matched set vehicle and trailer end connectors
- Repairs/replaces damaged 4 Flat
- Includes terminal grease



48285
4 Round Kit

- Tow vehicle end metal socket and trailer end metal plug
- Includes mounting bracket, wire, splices and hardware



48295
4 Round Set

- Tow vehicle end metal socket and trailer end metal plug



47975
4 Square Set

- 12 inch vehicle end
- 12 inch trailer end

(Special order only)



47985
5 Square Set

- 12 inch vehicle end
- 12 inch trailer end

(Special order only)



47995
6 Square Set

- 12 inch vehicle end
- 12 inch trailer end

DO IT ALL. TEST REPAIR & INSTALL

Our specialty components consist of items needed for installation or repair of towing electrical, test equipment to confirm everything is in working order and everything else needed to make a vehicle or trailer ready to tow.

THE HOPKINS® ADVANTAGE

CONSUMER TEST

Quick and easy testing of electrical functions



PROFESSIONAL TEST

Professional results in a convenient, do-it-yourself device





INSTALL CONVENIENCE

Everything needed for installation, maintenance and/or repair of vehicle or trailer wiring



POWER SERIES

Built in 12-Volt power where you need it



TEST LIKE A PROFESSIONAL

THE TOW DOCTOR™ IS IN

The Hopkins® Tow Doctor™ is designed so that one person can make sure their wiring has been installed correctly.



50918
Vehicle Wire Harness Test Set

- Tests all tow vehicle functions
- Includes 7 Blade, 6 Round and 4 Flat, test connectors

(With durable carrying case)

50944
7 Round Heavy-Duty Test Unit Adapter

50928
Trailer Wire Harness Test Set

- Tests all trailer functions
- Includes 7 Blade, 6 Round and 4 Flat test connectors
- Amperage meter shows actual amperage draw. For electric brakes, magnets are activated to determine correct operation

(With durable carrying case)

48655
4 Flat Tester Key chain

- LED indicator lights test left/right turn, brake and taillight
- Red LED light will glow if connection is correct

48675
4 Flat LED Dust Cover

- LED indicator lights test left/right turn, brake and taillight
- Red LED light will glow if connection is correct

48705 / 48709 (Bulk, 1 pk)
6 - 12 Volt Circuit Tester

- LED lights up when power is found
- Alligator clip for easy attachment
- Multi-use application

48715
4 Flat Tester with 6 - 12 Volt Circuit Tester

- LED indicator lights test left/right turn, brake and taillight
- Red LED light will glow if connection is correct



INSTALLATION COMPONENTS



39035 3/8" Convuluted Tubing

- Plastic sheathing protects wires from the elements
- Easily slips over wires
- Length, 10 feet



39045 1/2" Convuluted Tubing

- Plastic sheathing protects wires from the elements
- Easily slips over wires
- Length, 7 feet



48735 4 Flat Weatherproof Dust Covers

- Includes 2 dust covers and terminal grease packet for protecting 4 Flats from corrosion



49015 Splice Connectors (6 Pieces)

- 14-18 ga. wire splices



49905 14 Gauge Bonded Wire

- Length, 25 feet
- 100% copper 4 wire bonded
- 14 gauge on all wires
- Printed functions on wire



49915 16/18 Gauge Bonded Wire

- Length, 25 feet
- 100% copper 4 wire bonded
- 16 gauge on ground, 18 on all others
- Printed functions on wire



49955 16/18 Gauge Bonded Wire

- Length, 100 feet
- 100% copper 4 wire bonded
- 16 gauge on ground, 18 on all others
- Printed functions on wire



49975 12 Gauge Bonded Wire

- Length, 100 feet
- 100% copper 2 wire bonded
- 12 gauge on both wires



51000 Trailer Wiring Installation Kit (42 Pieces)

- Everything needed to rewire a trailer
- Includes specialty tool: 6-12 Volt circuit tester



51010 Trailer Wiring Installation Kit (43 Pieces)

- Everything needed to rewire a trailer
- Includes specialty tool: 6-12 Volt circuit tester and multi-purpose wire tool



51020 Deluxe Towing Electrical Accessories Kit (100 Pieces)

- Everything needed for installation, maintenance and repair of vehicle and trailer wiring
- Includes specialty tools: multi-purpose wire tool, terminal cleaner, grit sandpaper cloth and 6-12 Volt LED circuit tester



SPECIALTY CONNECTORS



55110 PATENTED 12-Volt Power Socket

- Flush-mount design, no drilling required
- Mounts anywhere 12-Volt power is needed



55115 PATENTED 12-Volt Power Socket

- Includes power wire and fuse assembly
- Length, 17 feet



55120 PATENTED 12-Volt Power Socket with Utility Light

- Provides LED utility light for multipurpose use
- Flush-mount design mounts 12-Volt power anywhere



55125 PATENTED 12-Volt Power Socket with Utility Light

- Includes power wire and fuse assembly
- Length, 17 feet



47955 4 Pole In-line Set

- Corrosion resistant tin-plated terminals
- Easy install to rear of connector

(Special order only)



37935 3 Pole Flat Extension

- Multi-use, male and female connectors
- 2 function wires with 1 ground wire
- Length, 12 inches

(Special order only)



47945 2 Pole In-line Set

- Corrosion resistant tin-plated terminals
- Easy install to rear of connector

(Special order only)



47965 / 47965B (Bulk, 20 pk) 2 Pole Flat Extension

- Multi-use positive/negative mating connectors
- 16 gauge copper wire
- Length, 12 inches



52002 1 Pole Round

- Die-cast zinc housing
- 300 Amp

(Special order only)

READY, GET SET, TOW.

Vehicle side connectors are electrical sockets typically mounted within or below a tow vehicle bumper for the purpose of trailer towing. These connectors provide the electrical outlet necessary for powering trailer lights, brakes or other electrical devices.



THE HOPKINS® ADVANTAGE

LARGEST SELECTION

7 Blade, 7 Round, 6 Round, 5 Flat, 5 Round
4 Flat, 4 Round and Sets



ENDURANCE™

Maximum durability and protection with
industry's best 3-year warranty



3 YEAR
WARRANTY

VEHICLE SIDE



VISIBLE WIRE DETAIL

Function details printed on the wire eliminates the guess work



EASIER TO GRIP

Struggling to get a grip is a thing of the past. Disconnecting is now easy



HASSLE-FREE HOOKUPS

Hitching up is now a one person job!



PATENT PENDING

50002
SMART HITCH™
Camera and Sensor System

3 Easy Steps for Installation

1 PLACE MONITOR

Place monitor in a desired location and route the wire to the rear of the vehicle



2 ATTACH SYSTEM

Simply attach camera and sensor system behind license plate



3 PLUG-IN SIMPLE!®

Connect the Plug-In Simple!® harness to existing tow package connector



Exact O.E.M. fit and Plug-In Simple!® for the following vehicle listing:



| FORD | | DODGE / RAM | |
|---------------------|----------------|------------------|----------------|
| F-150 | 2008-16 | 1500/2500/3500 | 2010-16 |
| F-250, 350 | 2008-16 | GMC | |
| Excursion | 2000-05 | Yukon/XL | 2000-15 |
| Explorer | 2014-16 | Canyon | 2008-12, 15-16 |
| Explorer Sport Trac | 2007-10 | Denali | 2001-14 |
| Flex | 2009-14 | Savana Van | 2008-16 |
| CHEVY | | Sierra 1500 | 2003-16 |
| 1500 | 2003-16 | Sierra 2500/3500 | 1999-16 |
| 2500/3500 | 1999-16 | TOYOTA | |
| Avalanche | 2002-13 | Tundra | 2014-15 |
| Tahoe | 2000-15 | LINCOLN | |
| Suburban | 2000-15 | Mark LT | 2006-08 |
| Colorado | 2008-12, 15-16 | NISSAN | |
| CADILLAC | | Armada | 2004-15 |
| Escalade | 2002-15 | Titan | 2004-16 |
| EXT / ESV | 07-15 | | |

For vehicles not listed, simply splice to reverse-light wire



SCAN HERE TO SEE IT IN ACTION



TWO MODES ARE BETTER THAN ONE



**CRYSTAL CLEAR
3.5 INCH
DUAL MODE DISPLAY**
Switch between Hitch Mode and
Everyday Mode at the touch of a button

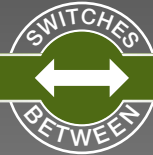

HITCH MODE

- Turns hitching into a one person job
- Helps align ball to trailer every time
- Provides a channel for perfect alignment
- Distance guides help determine how close objects are
- Audible alerts for proximity

EVERYDAY MODE

- Works for everyday use when not towing
- Detects objects 5.5 feet away
- Sends audible alert for when you're not looking
- Utilizes ultra-sonic sensing

MORE THAN A CAMERA

SmartZone™ sensors detect objects and alert you with an audible signal. The audible signal will intensify as your vehicle becomes closer to objects



"This is a great product and will probably save a few arguments with my wife"

- John H.
(2005 F-150 Crew Cab)



MERCHANDISING TOOLS AVAILABLE!

50002D
Smart Hitch™
Camera and Sensor System
Counter Display

- Dimensions: H - 13in.
W - 10.5in.
D - 6in.



VEHICLE SIDE CONNECTORS SELECTION CHART

Find the style of vehicle side connector you are looking for with the part numbers listed. For added value and consumer benefits look for the connector options with Endurance™, LED test and Multi-Tow® features.

| Vehicle Side | Description | BEST | | BETTER | GOOD |
|---|------------------|--|----------|------------|---|
| | | Endurance™ | LED Test | Multi-Tow® | Basic |
|  | 7 Blade p. 45 | 20022, 47180, 47200 47210, 48470, 48480 | | 47185 | 47205 48485 48495 |
|  | 7 Round p. 45 | | | | 52016 |
|  | 6 Round p. 45 | 48430 | | 47175 | 47155, 47165 48425, 48435 |
|  | 5 Flat p. 46 | 47900 | | | 47905 |
|  | 5 Round p. 46 | | | | 48365 |
|  | 4 Flat p. 46 | 48030 48190 | 48055 | | 46105, 48005, 48015 48025, 48035, 48045 48065 |
|  | 4 Round p. 47 | | | | 48305 52004 |



7 Blade

7 Blade connectors are typically used with large trailers (RV and industrial). These connectors provide the following functions: left/right turn, taillight, ground, auxiliary, electric brake, backup/reverse



20022 PATENTED ENDURANCE PROFESSIONAL GRADE Endurance™ 7 Blade Molded Cable

- Heavy-duty construction
- Cable length, 3 feet
- Mounts to vehicle bumper



NEW 2016 PATENTED ENDURANCE PROFESSIONAL GRADE 47180 Endurance™ Multi-Tow® 4 Flat to 7 Blade & 4 Flat

- Designed to retrofit existing mountings including "in-bumper" mounts with multiple towing options

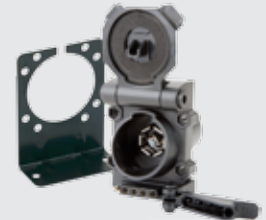

48470 PATENTED ENDURANCE PROFESSIONAL GRADE Endurance™ Multi-Tow® 7 Blade, 5 & 4 Flat

- Designed to retrofit existing mountings including "in-bumper" mounts with multiple towing options
- Includes mounting bracket, screws and terminal grease



47200 PATENTED ENDURANCE PROFESSIONAL GRADE 47204 (Bulk, 10 pk) (harness only) Endurance™ 4 Flat to 7 Blade Quick-Install™ Wiring Kit

- Allows existing 4 flat to adapt to the Quick-Install™ 7 Blade
- Quick and easy installation or replacement



47210 PATENTED ENDURANCE PROFESSIONAL GRADE 47214 (Bulk, 10 pk) (harness only) Endurance™ Universal Quick-Install™ Wiring Kit

- Pre-wired universal connection allows for flexibility in installation
- Reinforced lid opens 180° to prevent breaking



48480 PATENTED ENDURANCE PROFESSIONAL GRADE 48480B (Bulk, 20 pk) Endurance™ 7 Blade

- Includes mounting bracket, screws and terminal grease
- Durable lid opens 180°



47185 / 47185B (Bulk, 20 pk) PATENTED Multi-Tow® 4 Flat to 7 Blade & 4 Flat

- Designed to retrofit existing mountings including "in-bumper" mounts with multiple towing options
- Includes dust cover and connector lid for protection



47205 4 Flat to 7 Blade (Plastic)

- Flexible wire increases installation options
- Mounts to vehicle bumper



48485 (Plastic) / 48485B (Bulk, 20 pk) 48487 (Bulk, 50 pk) 7 Blade

- ABS plastic housing
- 48495 (Metal)
- Aluminum housing



7 Round

7 Round connectors are typically used with farming or commercial-fleet large trailers.



52016 7 Round (Metal)

- Heavy-duty die-cast zinc housing



6 Round

6 Pole connectors are typically used with horse trailers or utility/cargo trailers equipped with electric brakes. These connectors provide the following functions: left/right turn, taillight, ground, auxiliary, electric brake



47175 PATENTED Multi-Tow® 4 Flat to 6 Round & 4 Flat

- Provides multiple towing options from one connector
- Designed to retrofit existing mountings including "In-bumper" mounts



48430 PATENTED ENDURANCE PROFESSIONAL GRADE Endurance™ 6 Round (Metal)

- Durable lid opens 180°
- Heavy-duty die-cast zinc housing
- Added weatherproofing



47165 4 Flat to 6 Round (Metal)

- Flexible wire increases installation options
- Mounts to vehicle bumper



47155
4 Flat to 6 Round (Plastic)

- Flexible wire increases installation options
- Mounts to vehicle bumper
- Includes dust cover and terminal grease



6 Round (Metal)

- Heavy-duty die-cast zinc housing

48435
48435B (Bulk, 20 pk)
38438 (Bulk, 100 pk)



48425
6 Round (Plastic)

- ABS plastic housing

CORROSION RESISTANCE



Tin-plated brass terminals provide a corrosion resistant barrier



5 Flat

5 Flat connectors are typically used with marine applications. These connectors provide the following functions: left/right turn, taillight, ground and reverse



47900 PATENTED **ENDURANCE**
Endurance™ 5 Flat

- Length, 48 inches
- Includes terminal grease dust cover and ground screw
- Ergonomic grip



5 Flat
47905 / 47905B (Bulk, 20 pk)

- Length, 48 inches
- 37908** (Bulk, 50 pk)
- Length, 60 inches



5 Round

Die-cast connectors provide durability. These connectors provide the following functions: left/right turn, taillight, ground and either reverse, auxiliary or electric brake



48365
5 Round (Metal)

- Die-cast zinc housing



4 Flat

4 Flats are the most commonly used trailer plug. This plug is found on small boat, utility, jet ski, snowmobile and small camper trailers where right turn/brake, left turn/brake, tail/marker lights and ground is needed



46105
4 Flat Universal Kit

- Length, 48 inches
- Includes 3 splices, circuit tester, ground screw, dust cover, terminal grease and cable ties



48030 PATENTED **ENDURANCE**
Endurance™ 4 Flat

- Length, 48 inches
- Includes terminal grease, dust cover and ground screw
- Ergonomic grip for easier handling



48190 PATENTED **ENDURANCE**
Endurance™ Quick-Fix™ 4 Flat

- LED test lights confirm electrical functions
- Includes terminal grease and dust cover to protect terminals
- Repairs/ replaces damaged 4 flat



48055
LED Test 4 Flat

- Length, 48 inches
- LEDs verify that vehicle side wiring is correct
- Integrated "easy-pull" grip



48025 / 38038 (Bulk, 200 pk)
4 Flat

- 3 splices included
- Length, 48 inches



48035 / 48035B (Bulk, 20 pk)

4 Flat

- Length, 48 inches



48045

4 Flat

- Length, 60 inches



48065

4 Flat Knockout

- Length, 36 inches
- For use with 1.25 inch hole diameter or bracket #48605

(Special order only)



48005

4 Flat

- 3 splices included
- Length, 12 inches



48015

4 Flat

- Length, 12 inches



4 Round

Die-cast connectors provide durability. These connectors provide the following functions: left/right turn, taillight and ground



48305

4 Round (Metal)

- Die-cast zinc housing



52004

Heavy-Duty 4 Round (Metal)

- Heavy-duty die-cast zinc housing



Mounting Brackets

Mounting brackets create an additional support structure when mounting a vehicle side connector to the frame of a vehicle



48615 / 48615B (Bulk, 20 pk)

7 Blade Mounting Bracket

- Slotted for easily mounting pre-wired connectors
- Hardware included

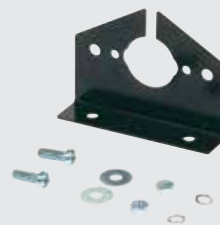

48605 / 48605B (Bulk, 20 pk)

4, 5 & 6 Round Mounting Bracket

- Slotted for easily mounting pre-wired harnesses
- Hardware included



48095

Mag-Flat™ Mounting Bracket

PATENTED

- Magnetic bracket keeps 4 Flat out of harm's way
- Works with standard vehicle and trailer 4 Flats



48595

4 Flat Mounting Bracket

- Folds over and secures 4 Flat in place
- Mounting screws included



48755

4 Flat Mounting Box

- Neatly stores 4 Flats out of harms way
- Mounting bracket and hardware included

INSTALLATION CONVENIENCE



Slots exist in mounting brackets for easily mounting pre-wired connectors

TAILLIGHT CONVERTERS

Electronic taillight converters adapt an independent bulb taillight system of the tow vehicle to the shared bulb taillight system of the trailer. If the brake light and turn signals operate from separate bulbs on the tow vehicle, and the brake light and turn signals operate from a shared bulb on the trailer, then a taillight converter is required.

INDEPENDENT BULB SYSTEM



INSTALLS ON VEHICLES WITH AN INDEPENDENT BULB SYSTEM

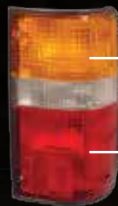

TURN SIGNAL

BRAKE LIGHT

SHARED BULB SYSTEM



CONNECTS TO TRAILERS WITH A SHARED BULB SYSTEM



TURN SIGNAL
BRAKE LIGHT

12-VOLT POWERED

Many newer vehicles are not equipped to handle the extra amp load trailer lights require.

A power converter provides 12-volt power directly from the tow vehicle's battery by passing sensitive electronics and providing brighter lights on the trailer.

Each power converter has a double-molded weatherproof housing, and includes a 20 foot battery feed wire (12 gauge), fuse, splices, terminal grease, dust cover, wire ties and ground screw.



46365



46375



46345



46255

ULTIMATE PROTECTION

Our most powerful converter providing capacity up to 8.0 Amps

PWM SYSTEMS

Some vehicles utilize a PWM (Pulse Width Modulation) type wiring system (or "multi-plex" system). These systems vary the signal intensity over a single wire to communicate more than one lighting function.

NEGATIVE INPUT SYSTEMS

Vehicles with Negative Input or "low side" (ground) switching systems, all circuits will initially be active. The signal lamp will turn off when a circuit is activated.

POWER CONVERTER

5.0 Amp capacity

NON-POWERED

In most cases, older vehicles do not need a powered converter.

NOTE: Check the owner's manual to determine if your vehicle has sophisticated electronics in need of power converter protection

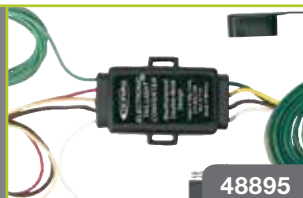

48895



46155

CONVERTER

Compatible with incandescent or LED tow vehicle taillight systems. Includes dust cover.

CONVERTER KIT

Includes everything necessary for installation...wire splices, dust cover, terminal grease, wire ties and ground screw. A circuit tester is also provided for assistance in determining wire function.



To determine AMP requirements count your trailer lights

- 1 Incandescent taillight bulb = 1 AMP
- 1 Incandescent marker light = .5 AMP

**2
AMP**

**5
AMP**

**8
AMP**

12V power
from battery

Tow vehicle electronic
protection

Self resetting after
short occurs

PWM compatible

Negative input
compatible

Tow vehicle
Incandescent bulb
compatible

Tow vehicle
LED bulb
compatible

| | 2 AMP | 5 AMP | 8 AMP | 12V power from battery | Tow vehicle electronic protection | Self resetting after short occurs | PWM compatible | Negative input compatible | Tow vehicle Incandescent bulb compatible | Tow vehicle LED bulb compatible |
|--|----------|----------|----------|---------------------------|--------------------------------------|--------------------------------------|----------------|------------------------------|--|---------------------------------------|
| | ● | ● | ● | ● | ● | ● | | | ● | ● |
| | ● | ● | ● | ● | ● | ● | ● | | ● | ● |
| | ● | ● | ● | ● | ● | ● | | ● | ● | ● |
| | ● | ● | | ● | ● | ● | | | ● | ● |
| | ● | | | | | | | | ● | ● |
| | ● | | | | | | | | ● | |

HOURS OF HASSLE GONE IN MINUTES.

Don't splice onto your vehicle's factory wiring harness. Simply plug in a Hopkins® vehicle wiring kit featuring Exact O.E.M. connectors for a perfect, weather-tight fit! These kits provide a 4 Flat or 7 Blade connector for your tow vehicle with all the mounting accessories.



THE HOPKINS® ADVANTAGE

EXACT O.E.M. FIT

O.E.M. connectors perfectly match the tow vehicle



VISIBLE WIRE DETAIL

Function details printed on the wire eliminates the guess work



VEHICLE WIRING KITS



EASY LOOKUP GUIDE

This QR code accesses a mobile drop-down guide. It helps the consumer select the correct wiring kit for their vehicle

SCAN HERE
TO SEE IT
IN ACTION



ACCESSORIES INCLUDED

Dielectric terminal grease and dust covers to protect terminals



SOLID GROUND

Serrated edge ring terminal for establishing a good ground



PLUG-IN SIMPLE![®] ENDURANCE[™] & MULTI-TOW[®] WIRING KITS

GUIDE A FOR 40940, 40950, 40955, 40965 & 40975

| AUDI / FORD / LINCOLN / SATURN | INFINITI / KIA / LEXUS / MERCURY / NISSAN | CHEVY / GMC | DODGE / RAM / HUMMER / JEEP / TOYOTA |
|--------------------------------|---|---|--------------------------------------|
| Q3 2009-15 | QX-56 / QX80 2004-15 | 1500 New Style 2003-13 | 1500 Pickups 2010-16 |
| Q5 2009-14 | Borrego 2009 | 2500 / 3500 New Style 1999-13 | 2500/3500 2010-16 |
| Q7 2007-15 | GX 460 2010-13 | 1500, 2500, 3500 2014-16 | Durango 2007-15 |
| Escape 2013-16 | LR4 (w/tow) 2013-14 | Avalanche 2002-13 | Journey 2009-10 |
| Excursion 2000-05 | LX 570 2003-13 | Colorado 2008-12, 15, 16 | Nitro 2007-09 |
| Expedition 1999-15 | Range Rover (w/tow) 2013-14 | Express Van 2008-16 | Promaster 2014-15 |
| Explorer 2002-16 | Mountaineer 2002-10 | Savanna Van 2008-16 | H2 / H2 SUT 2003-09 |
| Explorer Sport Trac 2007-10 | Pathfinder 2013-15 | Suburban 2000-15 | H3 / SUT 2006-09 |
| F-150 2008-16 | Armada 2004-15 | Tahoe 2000-15 | Cherokee 2014-16 |
| F-250, F-350 2008-16 | Titan 2004-16 | Traverse 2010-15 | Grand Cherokee 2011-15 |
| Aviator 2003-06 | BUICK / CADILLAC / CRYSLER / SAAB | Trailblazer 2002-16 | Liberty 2008-10 |
| E-Vans 2004-15 | Rainier 2004-07 | Acadia 2007-16 | 4-Runner 2010-13 |
| Flex 2009-15 | Enclave 2013-16 | Bravada 2002-04 | Sequoia 2010-14 |
| Mark LT 2006-08 | Escalade / EXT / ESV 2002-15 | Canyon 2008-12, 15, 16 | Tundra 2014-15 |
| MKT 2009-14 | SRX 2010-14 | Envoy 2002-09 | ISUZU / VOLKSWAGON / OLDS |
| Navigator 1999-15 | Aspen 2007-09 | Denali 2001-14 | Ascender 2004-08 |
| Outlook 2007-09 | 9-7X 2005-10 | Yukon / XL / Denali 2000-15 | Touareg 2012-15 |
| Transit 2015-16 | | MERCEDES BENZ / PORSCHE / SATURN | Bravada 2002-04 |
| | | M Class 1998-14 | |
| | | Cayenne 2013-14 | |
| | | Outlook 2007-10 | |



BACK VIEW

40940

PATENTED

ENDURANCE
PROFESSIONAL GRADE

40941 (Bulk, 20 pk)

Endurance™ 7 Blade O.E.M. Replacement

- Compatible with Ford, GM and other popular tow vehicles.
- Plug-In Simple![®] for quick and easy installation or replacement



BACK VIEW

40950

PATENTED

ENDURANCE
PROFESSIONAL GRADE

40951 (Bulk, 20 pk)

Endurance™ Multi-Tow® 7 Blade & 4 Flat O.E.M. Replacement

- Compatible with Ford, GM and other popular tow vehicles.
- Plug-In Simple![®] for quick and easy installation or replacement



PATENTED

40955

40959 (Bulk) / **40955B** (Bulk, 20 pk)

Multi-Tow® 7 Blade & 4 Flat

- 7 Blade and 4 Flat towing
- Includes and fits 7 Blade bracket



PATENTED

40965

Multi-Tow® 6:4

- 6 Round and 4 Flat towing
- Includes and fits 7 Blade bracket



BACK VIEW

40974 (Connector Only)

NEW 2016

PATENTED

40975 (Connector and Bracket)

40974B (Connector Only - Bulk, 18 pk)

40978 (Bracket Only - Bulk, 18 pk)

Multi-Tow® 7 Blade & 4 Flat O.E.M. Replacement

- 7 Blade and 4 Flat towing



40975



42191

Harness for Dodge, Chrysler & Jeep

- Allows for Dodge trucks to adapt to 40940, 40950, 40955, 40965, 40974 and 40975

UNIVERSAL HARNESS

This pre-wired tow package harness allows you to retrofit any vehicle to a wide range of our Multi-Tow[®] and Endurance[™] connectors.



40985

- Pre-wired universal connection allows for flexible installation
- For use with 40920, 40930, 40940, 40950, 40955, 40965, 40974 and 40975

ENDURANCE™

PROFESSIONAL GRADE

Designed with maximum durability and enhanced weatherproofing to provide years of trouble-free use



MULTI-TOW®

Provides multiple towing options from one vehicle-end connector. For added convenience, these kits mount within the universal mounting hole



GUIDE B FOR 42145 & 42190

| DODGE / RAM / MITSUBISHI | |
|----------------------------|------------|
| Ram 1500 | 2000-09 |
| Ram 2500/3500 | 2000-09 |
| Trandsman Van | 2014-15 |
| Ram Van | 2001-03 |
| Dakota | 2000-10 |
| Durango | 2000-07 |
| Sprinter | 2004-09 |
| Raider | 2006-08 |
| CHRYSLER / JEEP / MERCEDES | |
| Aspen | Early 2007 |
| Pacifica | 2003-08 |
| Commander | 2006-10 |
| Grand Cherokee | 2000-10 |
| Liberty | 2004-07 |
| Wrangler | 2004-16 |
| GL-Class | 2007-10 |



42190 PATENTED ENDURANCE PROFESSIONAL GRADE

Endurance™ Dodge / Chrysler / Jeep O.E.M. Quick-Install™ Wiring Kit

- Allows for Dodge trucks to adapt to the Quick-Install™ 7 Blade
- Plug-In Simple!® for quick and easy installation or replacement



42145 PATENTED

Dodge / Chrysler / Jeep Multi-Tow® 7 Blade & 4 Flat

- 7 Blade and 4 Flat towing
- Includes and fits 7 Blade bracket

QUICK & SIMPLE TWIST-MOUNT INSTALLATION



The Endurance™ Twist-Mount 7 Blade Connector is compatible with GM Tow vehicles from 2000 to the current year. Incorporating Endurance™ design features to last for years of trouble-free use.

GUIDE C FOR 40920 & 40930

| BUICK / CADILLAC | | GMC / SATURN | |
|----------------------|---------|---------------------------|---------|
| Enclave | 2013-16 | Acadia | 2013-16 |
| Escalade / EXT / ESV | 2014-15 | 1500 Pickups | 2003-13 |
| Rainier | 2004-07 | 2500 / 3500 Pickups | 1999-15 |
| CHEVY | | Denali | |
| Avalanche | 2002-13 | Envoy (with tow pkg) | 2002-09 |
| 1500 Pickups | 2003-13 | Outlook | 2007-10 |
| 2500 / 3500 Pickups | 1999-13 | Yukon | 2000-15 |
| Suburban | | ISUZU / OLDSMOBILE / SAAB | |
| Tahoe | 2007-15 | Ascender | 2004-08 |
| Trailblazer | 2002-09 | Bravada | 2002-04 |
| Traverse | 2013-16 | 9-7X | 2005-10 |



40920 PATENTED ENDURANCE PROFESSIONAL GRADE

Endurance™ Multi-Tow® 7 Blade & 4 Flat GM Twist-Mount

- Exact O.E.M. Fit
- Plug-In Simple!® for quick and easy installation or replacement
- Refer to Guide C for vehicle make/model fit list



40930 PATENTED ENDURANCE PROFESSIONAL GRADE

Endurance™ 7 Blade GM Twist-Mount

- Exact O.E.M. Fit
- Plug-In Simple!® for quick and easy installation or replacement
- Refer to Guide C for vehicle make/model fit list

VEHICLE SPECIFIC WIRING KITS

All wiring kits offered on the following pages are Plug-In Simple!® meaning they perfectly match the tow vehicle's connectors for a weather tight fit. They also include mounting accessories, dust covers and grease packets.

THE HOPKINS® ADVANTAGE

NEW FOR 2016 **NEW 2016**

We continue to research, develop and expand our vehicle wiring kit segment to meet consumer demand



EXACT O.E.M. FIT

Our O.E.M. connectors perfectly match the tow vehicle



ACCESSORIES INCLUDED

Dielectric terminal grease and dust covers to protect terminals

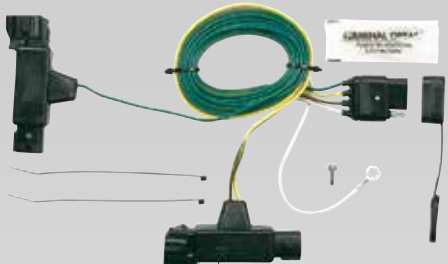

WIRING KITS

Vehicles with shared lighting systems, that are equipped to handle the extra amp load trailer lights require, will use this Plug-In Simple!® solution. These wiring kits will consolidate the vehicle's connectors to a 4 Flat.

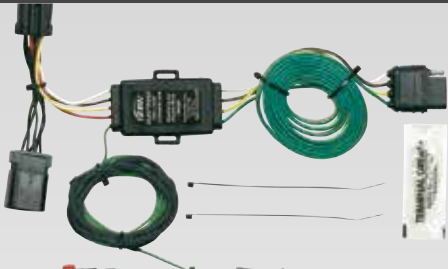

WIRING KITS WITH NON-POWERED CONVERTERS

Many vehicles on the road possess independent lighting systems. These wiring kits offer a Plug-In Simple!® Solution that adapts the vehicle's independent lighting system to the trailer's shared lighting system and consolidates the vehicle's connectors to a 4 Flat.



WIRING KITS WITH 12-VOLT POWER CONVERTERS

Many modern vehicles have sophisticated wiring systems that are not equipped to handle the extra amp load trailer lights require. These wiring kits, with a built-in power converter provide protection for the vehicle's complex systems. These wiring kits will consolidate the vehicle's connectors to a 4 Flat.

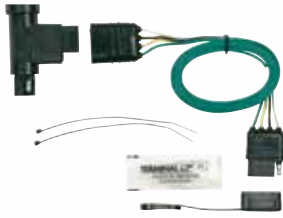

40105

FORD

F-Series Pickup

1973-79

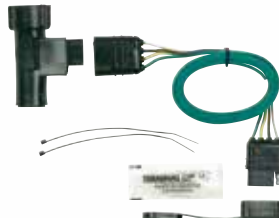

40115

FORD

Bronco
F-Series Pickup

1980-86
1980-86

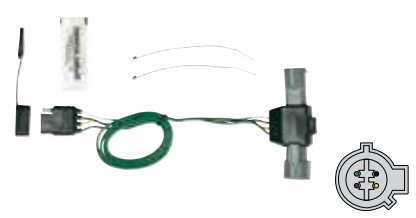

40125

FORD

F-150, 250, 350
F-250 Heavy Duty, F-350

1987-96
1987-97



40135

FORD / LINCOLN

Expedition 1997-03
F-150 (mfg. 1/96 - 10/96) 1997
F-250 Light Duty (mfg. 1/96 - 10/96) 1997
Navigator 1997-99



40145

FORD

F-150 (mfg. 11/96 - 03) 1997-03
F-150 (Regular cab only) 2004
F-250 Light Duty (mfg. 11/96 - 2001) 1997-01



40155

FORD

F-250 Heavy Duty, F-350 1999-01



40165

FORD

F-250 Heavy Duty, F-350

2002-04

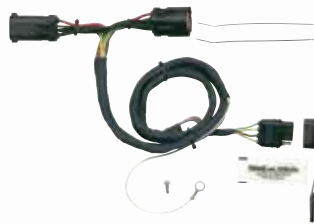

40175

FORD

F-150 (New body style)

2004



40185

FORD

F-150

2005-08

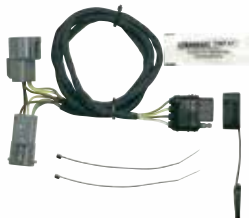

40195

FORD

F-250 Heavy Duty, F-350

2005-07

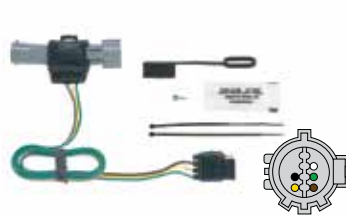

40205

FORD

Ranger

1986-92

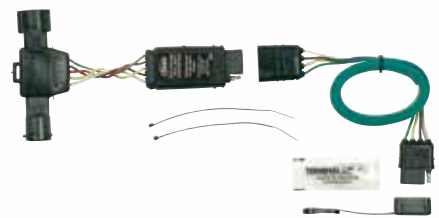

40215

FORD / MAZDA

Ranger
B-Series

1986-99
1994-09

Includes taillight converter



40235

MAZDA

Miata MX-5
MPV Van

1999-05
2000-06

Includes short-proof power converter



40245

MAZDA

6

2009-13

Includes short-proof power converter

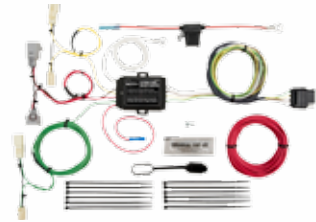

40254 **NEW 2016**

MAZDA

6

2014-16

Includes short-proof power converter

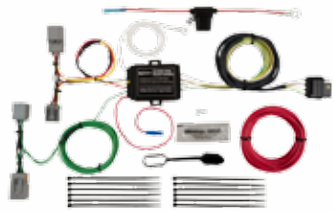

40264 **NEW 2016**

FORD

Transit Connect

2014-15

Includes short-proof power converter



40265

MAZDA

5

CX-9

2006-15

2007-14

Includes short-proof power converter

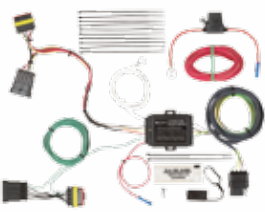

40274

FIAT

500 (all)

2012-15

Includes short-proof power converter



40275

FORD

Flex

2009-15



40285

FORD

Explorer

2011-16

Includes short-proof power converter



40305

FORD / MAZDA

Explorer

Navajo

1991-94

1991-94



40314

LINCOLN

MKX

2011-16

Includes short-proof power converter

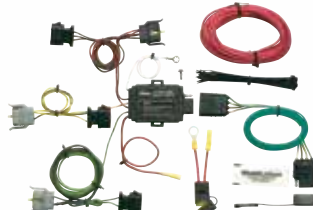

40315

FORD / MAZDA / MERCURY

Escape (Early 2004)

Explorer

Econoline Van

Tribute

Mountaineer

2001-04

1995-00

1992-94

2001-03

1997-00

Includes short-proof power converter



40324

LINCOLN

MKZ

2013-16

Includes short-proof power converter

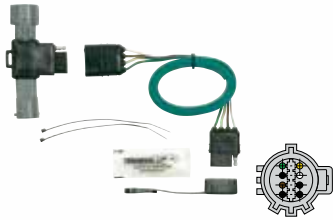

40325

FORD / MERCURY

| | |
|-------------|---------|
| Explorer | 1996-97 |
| Mountaineer | 1996-97 |



40335

FORD / LINCOLN / MERCURY

| | |
|---------------------------------|---------|
| Explorer (w/ factory 4 flat) | 2002-05 |
| Aviator (w/ factory 4 flat) | 2003-05 |
| Mountaineer (w/ factory 4 flat) | 2002-05 |

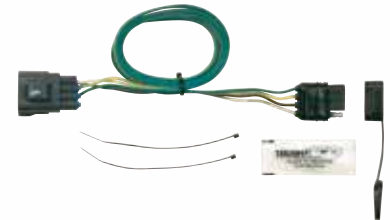

40345

FORD / LINCOLN / MERCURY

| | |
|-------------|---------|
| Explorer | 2006-10 |
| Aviator | 2006 |
| Mountaineer | 2006-10 |



40355

LINCOLN

| | |
|----|---------|
| LS | 2000-06 |
|----|---------|

VEHICLE APPLICATION EXPANSION

We continue to expand our application specific Vehicle Wiring Kit segment by introducing an unprecedented number of new applications to address the ever changing mix of tow, crossover and passenger vehicles. This evolution focuses on consumer demand and buying trends. Look for the **NEW 2016** throughout this section.

Includes short-proof negative input power converter



40375

FORD / LINCOLN

| | |
|----------------|---------|
| Fiesta (5 dr.) | 2011-15 |
| MKS | 2009-15 |



40385

LINCOLN

| | |
|-------------------|---------|
| MKT (w/o tow pkg) | 2009-14 |
|-------------------|---------|



40395

LINCOLN / MERCURY

| | |
|-------|---------|
| MKZ | 2007-09 |
| Milan | 2007-10 |

Includes short-proof power converter

Includes short-proof power converter

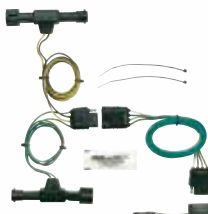

40405

FORD

| | |
|-----------|---------|
| Bronco II | 1987-91 |
|-----------|---------|

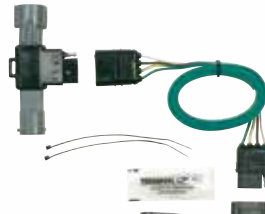

40415

FORD

| | |
|--------|---------|
| Bronco | 1987-88 |
|--------|---------|

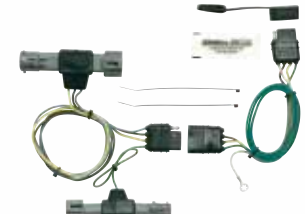

40425

FORD

| | |
|--------|---------|
| Bronco | 1989-91 |
|--------|---------|



40435

FORD

Bronco

1992-96



40444

FORD

Fusion

2013-16



40445

FORD / MAZDA

Escape (w/ tow pkg)
Tribute (w/ tow pkg)

2001-04
2001-04

Includes short-proof power converter



40455

FORD / MAZDA / MERCURY

Escape (w/ tow pkg)
Tribute (w/ tow pkg)
Mariner (w/ tow pkg)

2005-07
2005-06
2005-07



40464

FORD

Fiesta (4 dr.) (Sedan)

2014-15

Includes short-proof power converter

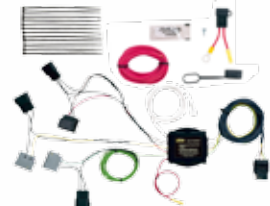

40465

FORD / MAZDA

Escape
Tribute (w/o tow pkg)

2005-07
2005-06

Includes short-proof power converter



40475

FORD / MERCURY

Five Hundred
Freestyle

2005-07
2005-07



40485

FORD

Fiesta 4 dr. (Sedan)

2011-13

Includes taillight converter



40495

CHEVROLET / FORD / LINCOLN / MAZDA / MERCURY

| | | | | | |
|-----------|---------|-------------------------|---------|----------|---------|
| Camaro | 2012-16 | Ranger Pickup (w/o STX) | 2011 | Corvette | 2005-12 |
| Edge | 2007-10 | MKX | 2007-10 | Escape | 2008-12 |
| Navigator | 2003-15 | Focus (except Sedan) | 2004-07 | Tribute | 2008-11 |
| Focus | 2008-11 | Mariner | 2005-11 | | |

Econoline E-Series Van (w/o tow pkg) 2004-15

Includes short-proof power converter



40504

FORD

Crown Victoria / LTD / No police interceptor 1998-03

Includes short-proof power converter



40505

FORD / LINCOLN / MERCURY

| | |
|------------------------|---------|
| Crown Victoria / LCD | 1992-97 |
| Mustang (Except Cobra) | 1994-04 |
| Town Car | 1998-04 |
| Grand Marquis | 1992-97 |

40514

FORD

Escape 2013-16

Includes short-proof power converter

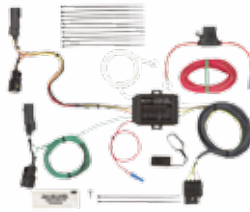

40525

FORD

Mustang 2010-16

Includes short-proof power converter



40535

FORD

Taurus X 2008-09

40545

FORD

Focus (Sedan) 2012-16

Includes short-proof power converter

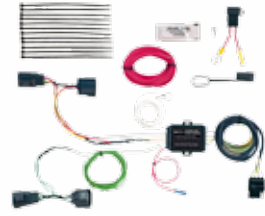

40554

FORD

Focus (Hatchback) (5 door) 2012-16

Includes short-proof power converter



40555

FORD

Taurus (Sedan) 1992-95

Includes taillight converter

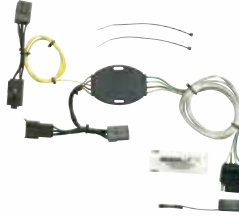

40565

FORD / MERCURY

| | |
|----------------|---------|
| Taurus (Sedan) | 1996-99 |
| Sable (Sedan) | 1996-99 |

Includes taillight converter



40575

FORD / MERCURY

| | |
|----------------|---------|
| Taurus (Sedan) | 2000-03 |
| Sable (Sedan) | 2000-03 |

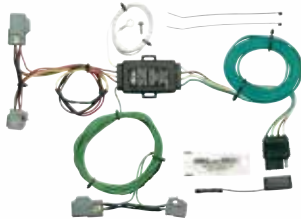

40585

FORD / MERCURY

| | |
|----------------|---------|
| Taurus (Sedan) | 2008-09 |
| Sable (Sedan) | 2008-09 |

Includes taillight converter

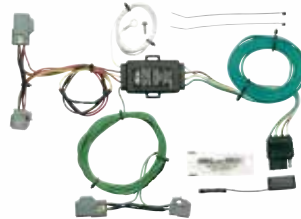

40595

FORD

Taurus (Sedan) 2010-12

Includes taillight converter

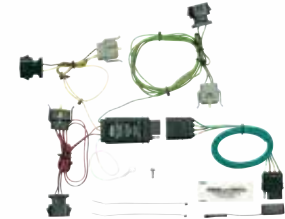

40605

FORD

Windstar 1995-98

Includes taillight converter



40615

FORD

Windstar (mfg. 1999-12/02) 1999-02

Includes short-proof negative input power converter

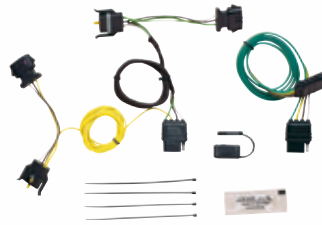

40655

FORD / LINCOLN / MERCURY

| | | | |
|--------------------------------------|---------|---------------------------|---------|
| Aerostar | 1997 | Ranger Pickup (w/o STX) | 2000-10 |
| Escort (Sedan) | 1997-01 | Econoline Van | 1995-03 |
| Excursion (w/o tow) | 2000-03 | ZX2 | 1998-03 |
| Expedition (w/o tow) | 1997-03 | Aviator (w/o tow pkg) | 1998-03 |
| Explorer (2 dr. sport) (w/o tow pkg) | 2001-03 | Aviator (w/o tow pkg) | 2003-04 |
| Explorer (4 door) (w/o tow pkg) | 2002-03 | Mountaineer (w/o tow pkg) | 2002-03 |
| Explorer Sport Trac (w/o tow pkg) | 2002-03 | Tracer | 1997-99 |
| Focus Wagon (built before 11/2002) | 2000-03 | | |



40665

FORD

Econoline Van (w/ factory 4 flat) 2009-13



40685

FORD

Fusion 2006-12

Includes short-proof power converter



40695

FORD

Edge 2011-13

Includes short-proof power converter



40735

FORD

F-150 2009-15

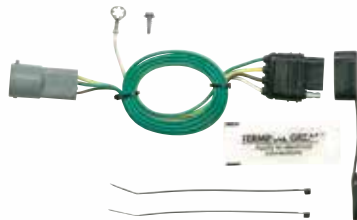

40755

FORD

F-250, 350 (All) 2008-16

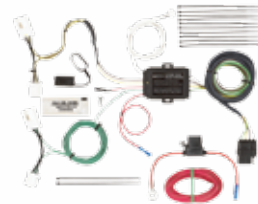

40804

INFINITI

FX 45 2004-06

Includes short-proof power converter



40805

INFINITI

FX 35 2009-13
 FX 37, QX70 2009-16
 FX 50 2009-15

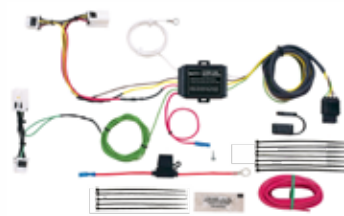

40825

INFINITI

G25X (Sedan) 2010-13
 G37 (Sedan), Q50 2009-15

Includes short-proof power converter

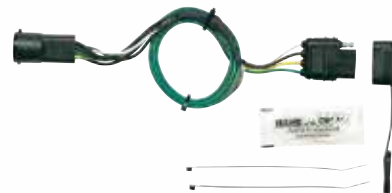

40905

FORD / MAZDA

Explorer (w/ tow pkg) 1991-94
 Navajo (w/ tow pkg) 1991-94

Includes short-proof power converter



40915

FORD / MAZDA / MERCURY

| | |
|--------------------------|---------|
| Explorer (w/ tow pkg) | 1995-01 |
| Ranger (w/ tow pkg) | 1998-99 |
| PU B-Series (w/ tow pkg) | 1998-99 |
| Mountaineer (w/ tow pkg) | 1996-01 |



40920



GM TWIST-MOUNT MULTI-TOW®

7 Blade and 4 Flat

See page 53 (Guide C)



40925

FORD / LINCOLN

| | |
|--------------------------------|---------|
| Expedition (w/ factory 4 flat) | 2000-02 |
| Navigator | 2000-02 |



40930



GM TWIST-MOUNT

7 Blade

See page 53 (Guide C)



40935

SATURN

VUE 2002-07

Includes short-proof power converter



40940



MULTIPLE MAKES O.E.M. REPLACEMENT

7 Blade

See page 52 (Guide A)



40950



MULTIPLE MAKES MULTI-TOW®

7 Blade and 4 Flat

See page 52 (Guide A)



40955



MULTIPLE MAKES MULTI-TOW®

7 Blade and 4 Flat

See page 52 (Guide A)



40965



MULTIPLE MAKES MULTI-TOW®

6 Round and 4 Flat

See page 52 (Guide A)



40974



MULTI-TOW® O.E.M. REPLACEMENT

7 Blade and 4 Flat

See page 52 (Guide A)



40975



MULTI-TOW® O.E.M. REPLACEMENT

(Bracket Included)
7 Blade and 4 Flat

See page 52 (Guide A)

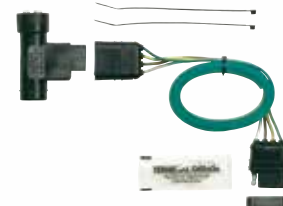

41105

CHEVROLET / GMC

| | |
|--------------------|---------|
| Blazer (full size) | 1973-84 |
| Pickup (full size) | 1968-84 |
| Suburban | 1973-84 |
| Jimmy (full size) | 1973-84 |
| Pickup (full size) | 1968-84 |
| Suburban | 1973-84 |

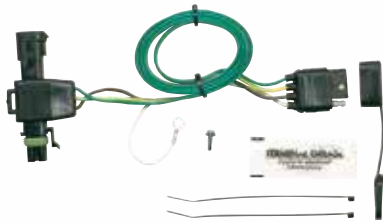

41115

CHEVROLET / GMC / ISUZU

| | |
|----------------------------|---------------------|
| Blazer (full size) 1985-91 | Sonoma/S-15 1985-97 |
| Pickup (full size) 1985-87 | Suburban 1985-91 |
| S-10 Pickup 1985-97 | Cyclone 1991-92 |
| Hombre 1996-97 | |
| Jimmy (full size) 1985-91 | |
| Pickup (full size) 1985-87 | |

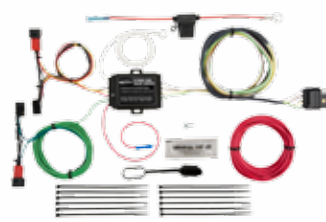

41120 NEW 2016

CHEVROLET

| | |
|-------|---------|
| Spark | 2013-15 |
|-------|---------|

Includes short-proof power converter

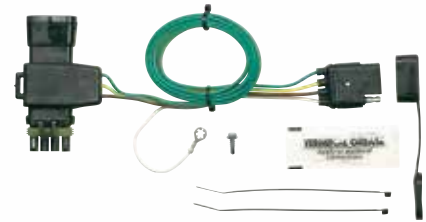

41125

CADILLAC / CHEVROLET / GMC

| | |
|------------------------------|------------------------------|
| Escalade 1999-00 | Denali 1999-00 |
| Blazer (full size) 1992-94 | Jimmy (full size) 1992-94 |
| Pickup (full size) 1988-98 | P/U (old body style) 1999-00 |
| P/U (old body style) 1999-00 | Yukon 1992-99 |
| Suburban 1992-99 | |
| Tahoe 1995-99 | |

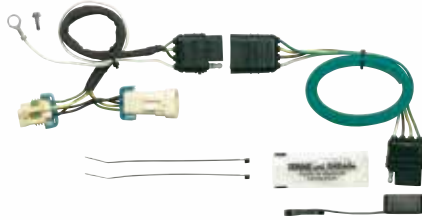

41135

CHEVROLET / GMC / ISUZU

| | |
|----------------------|---------|
| S-10 Pickup | 1998-04 |
| Sonoma / S-15 Pickup | 1998-04 |
| Hombre | 1998-01 |



41144 NEW 2016

PATENTED

CHEVROLET / GMC

| | |
|------------------------|---------|
| Colorado (w/o tow pkg) | 2015-16 |
| Canyon (w/o tow pkg) | 2015-16 |

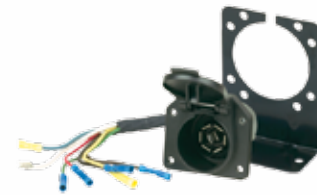

41145

CHEVROLET / GMC

| | |
|------------------------------|---------|
| Silverado 1500 (New Body) | 1999-02 |
| Sierra 1500 (New body style) | 1999-02 |



41150 NEW 2016

CHEVROLET

| | |
|--------------------|---------|
| Traverse (w/o tow) | 2013-16 |
|--------------------|---------|

Includes short-proof power converter



41155

MULTIPLE MAKES O.E.M. REPLACEMENT

| | |
|--------|--|
| 4 Flat | |
|--------|--|

See page 52 (Guide A)



41164 NEW 2016

CHEVROLET / GMC

| | |
|--------------------|---------|
| Colorado (w/o tow) | 2015-16 |
| Canyon | 2015-16 |

Includes short-proof power converter

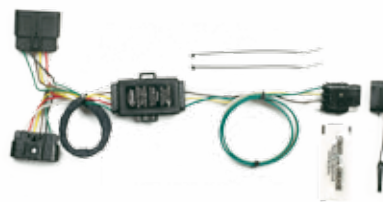

41165

CHEVROLET / GMC / ISUZU

| | | |
|----------------------------|-------|---------|
| Colorado 2004-07 | I-280 | 2006 |
| Colorado (w/o tow) 2008-12 | I-290 | 2007-08 |
| Canyon 2004-07 | I-350 | 2006 |
| Canyon (w/o tow) 2008-12 | I-370 | 2007-08 |

Includes taillight converter

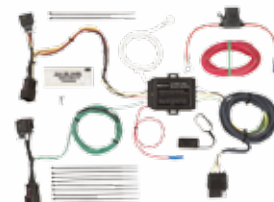

41174

CHEVROLET

| | |
|-----------------|---------|
| Sonic (4 door) | 2012-16 |
| Sonic Hatchback | 2013-16 |

Includes short-proof power converter



41175

BUICK / CHEVROLET / PONTIAC / SATURN

| | |
|-------------|---------|
| Terraza | 2005-07 |
| Uplander | 2005-08 |
| Montana SV6 | 2005-06 |
| Relay | 2005-07 |



41185

BUICK / CHEVROLET

| | |
|------------|---------|
| Roadmaster | 1991-96 |
| Caprice | 1994-96 |
| Impala SS | 1994-96 |



41195

BUICK / CHEVROLET / OLDSMOBILE

| | |
|-------------------------|---------|
| Roadmaster Estate Wagon | 1991-96 |
| Caprice Wagon | 1991-96 |
| Custom Cruiser | 1991-92 |

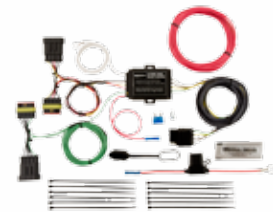

41204

FIAT

| | |
|------|---------|
| 500L | 2014-15 |
|------|---------|

Includes short-proof power converter



41205

CHEVROLET / GMC

| | |
|----------------------|---------|
| S-10 Blazer (2 door) | 1984-91 |
| S-15 Jimmy (2 door) | 1984-91 |



41215

CHEVROLET / GMC

| | |
|----------------------|---------|
| S-10 Blazer (2 door) | 1992-94 |
| S-15 Jimmy (2 door) | 1992-94 |

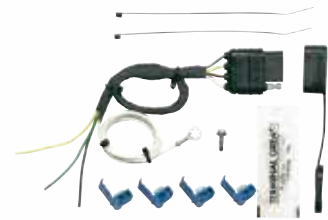

41225

CHEVROLET / GMC / OLDSMOBILE

| | |
|---------|---------|
| Astro | 1995-05 |
| Blazer | 1995-04 |
| Envoy | 1999-01 |
| Jimmy | 1995-02 |
| Safari | 1995-05 |
| Bravada | 1996-01 |



41235

CHEVROLET / PONTIAC

| | |
|---------|---------|
| Equinox | 2004-06 |
| Torrent | 2006 |

Includes short-proof power converter

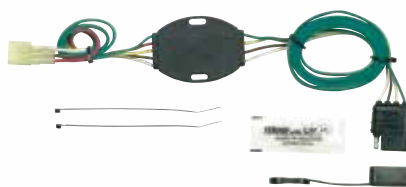

41245

CHEVROLET / GEO / SUZUKI

| | |
|-----------------------|---------|
| Tracker | 1998-04 |
| Tracker | 1996-05 |
| Vitara / Grand Vitara | 1999-05 |
| XL-7 | 2001-05 |

Includes taillight converter



41254

SUZUKI

| | |
|---------|---------|
| Kizashi | 2010-11 |
|---------|---------|

Includes short-proof power converter



41255

SUZUKI

| | |
|-----------------------|---------|
| Vitara / Grand Vitara | 2006-12 |
| SX4 | 2007-11 |

Includes taillight converter



41265

CHEVROLET / PONTIAC

| | |
|---------|---------|
| Equinox | 2007-09 |
| Torrent | 2007-09 |



41275

CHEVROLET / GMC

| | |
|----------------------|---------|
| Equinox | 2010-16 |
| Terrain (w/ tow pkg) | 2010-16 |



Plug-In Simple![®]
connectors
perfectly
match
the tow
vehicle



41285

CHEVROLET

Camaro

2010-11



41295

CHEVROLET

Aveo (4 Dr.) (Sedan) Knotchback

2007-11

Includes short-proof power converter



41300

BUICK

Encore

2013-16

Includes short-proof power converter

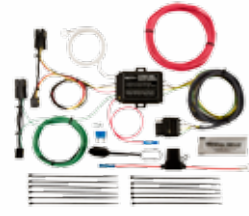

41304

CHEVROLET

Captiva

2012-14

Includes short-proof power converter

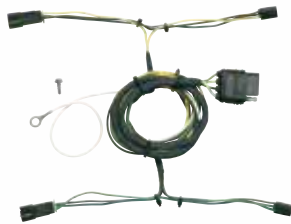

41305

CHEVROLET / GMC

Van (full size)(except Express)
Vandura (full size)

1987-96
1987-96

Includes taillight converter

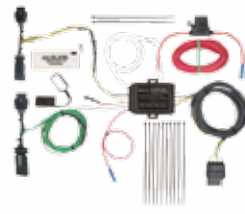

41310

BUICK / GMC

Enclave (w/o tow pkg)
Acadia (w/o tow pkg)

2013-16
2013-16

Includes short-proof power converter



41315

BUICK

LaCrosse

2010-16

Includes short-proof power converter



41325

CHEVROLET / GMC

Express Van
Savana Van (full size)

1996-99
1996-99

Includes taillight converter

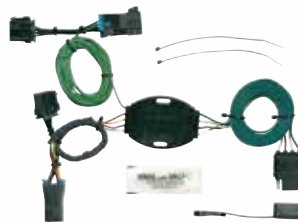

41335

CHEVROLET / GMC

Express Van
Savana Van (full size)

2000-02
2000-02

Includes taillight converter



41345

CHEVROLET / GMC

Express Van
Savana Van (full size)

2003-16
2003-15

Includes short-proof power converter



41355

CHEVROLET / OLDSMOBILE / PONTIAC

Lumina APV Van 1993-96
Silhouette 1993-96
Trans Sport Van 1993-96

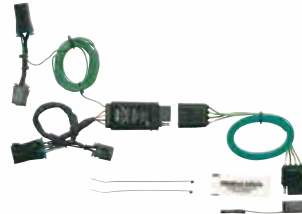

41365

CHEVROLET / OLDSMOBILE / PONTIAC

Venture 1997-05
Silhouette 1997-05
Montana 1997-06
Trans Sport Van 1997-04

Includes taillight converter



41374

BUICK

Verano 2012-16

Includes short-proof power converter



41375

BUICK

Regal 2011-13

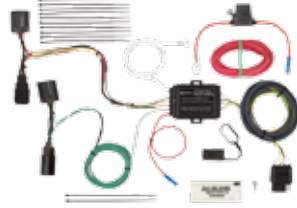

41384 **NEW 2016**

BUICK

Regal 2014-16

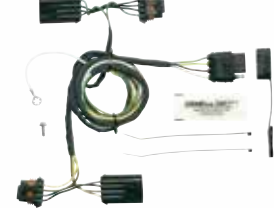

41385

BUICK

LaCrosse 2005-09

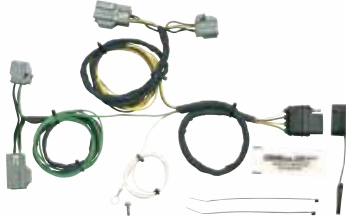

41395

BUICK

Lucerne 2006-11



41405

BUICK / PONTIAC

Rendezvous 2002-07
Aztek 2001-05



41415

CHEVROLET

Aveo (5 Dr.) (Hatchback) 2004-11

Includes short-proof power converter



41425

PONTIAC

Vibe 2003-08

Includes short-proof power converter

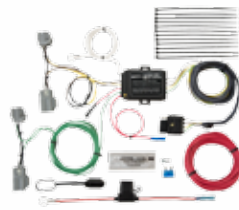

41434

CHEVROLET

Impala 2014-16

Includes short-proof power converter

KITS UTILIZE 16/18 GAUGE COPPER WIRE WITH PRINTED WIRE FUNCTION

- Produces brighter taillights
- Easy wire function identification





41435

CHEVROLET

Cruze

2011-16

Includes short-proof power converter



41474

CADILLAC

ELR

2014

Includes short-proof power converter



41475

CADILLAC

SRX

2010-16



41485

CADILLAC

CTS

2003-07

CTS-V

2004-07

Includes short-proof power converter



41495

CADILLAC

CTS, CTS-V

2008-16

Includes short-proof power converter

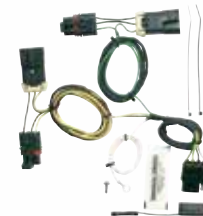

41555

CHEVROLET / PONTIAC

Cobalt / SS (2 door)

2005-10

Cobalt Sport (2 door)

2008-10

HHR

2006-11

HHR Sport

2008-11

G5 (2 door)

2007-10

G5 GT (2 door)

2007-10

Persuit (2 door)

2005-10

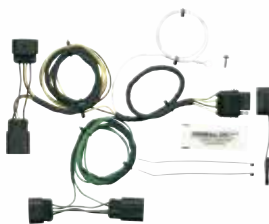

41565

CHEVROLET / PONTIAC

Cobalt / SS (4 door)

2005-10

Cobalt Sport (4 door)

2008-10

G5 (4 door)

2007-09

Persuit (4 door)

2005-10

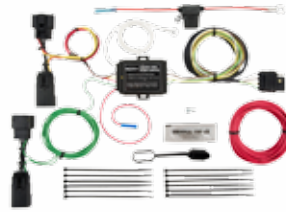

41575 **NEW 2016**

CHEVROLET

Corvette

2014-16

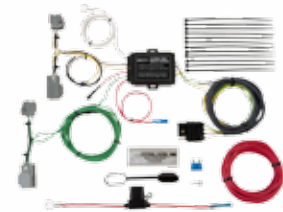

41585

CHEVROLET

SS

2014-16

Includes short-proof power converter



41595

CHEVROLET

Impala

2006-13



41605

CHEVROLET / PONTIAC

Malibu

2004-07

G6

2005-09

Includes short-proof power converter



41615

BUICK / CHEVROLET

Enclave

2008-12

Malibu (Except LTZ)

2008-12

Traverse

2009-12

Includes short-proof power converter



41625 **NEW 2016**

CHEVROLET

Malibu

2013-16



41645

GMC

Acadia (w/o tow pkg)

2007-12

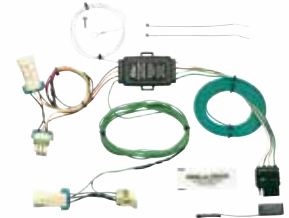

41705

SATURN

Aura

2007-09

Includes taillight converter

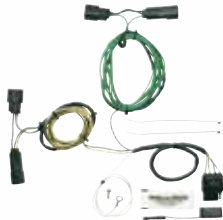

41725

SATURN

Outlook

2007-10



41745

SATURN

VUE

2008-10

Includes short-proof power converter



41765

TOYOTA

Camry

1997-01

Includes taillight converter



41775

TOYOTA

Camry

2002-06

Includes short-proof power converter



41795

MITSUBISHI / TOYOTA

Outlander

2014

Avalon

2011-12

Camry (Hybrid)

2007-09

Camry

2010-11

Venza

2009-15

Includes short-proof power converter



41815

TOYOTA

Corolla

2009-13

Includes short-proof power converter



41820

TOYOTA

Avalon

2013-15

RAV 4

2013-15

Includes short-proof power converter

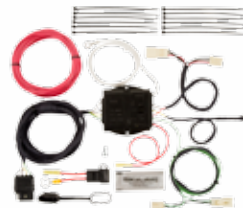

41824

MAZDA / TOYOTA

3

2014-15

Camry

2007-09

CX-7

2007-09

6

2003-08

Camry, Camry Hybrid

2012-16

Corolla

2014-16

Miata MX-5

2006-14

FJ Cruiser

2007-14

Includes short-proof power converter



41825

TOYOTA

Highlander (w/ tow pkg)

2008-15

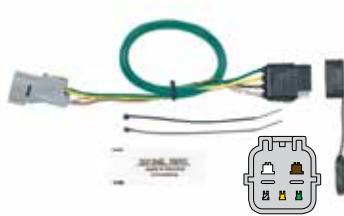

41835

TOYOTA

Tundra (w/ factory 4 flat)

2010-15



41844

TOYOTA

Yaris

2010-15

Includes short-proof power converter



41845

TOYOTA

Highlander (w/o tow pkg)

2008-15

Includes short-proof power converter



41854

TOYOTA

Prius

2004-15

Includes short-proof power converter



41855

TOYOTA

4-Runner (w/ tow pkg)

2010-14

PATENTED ENDURANCE
PROFESSIONAL GRADE

Includes short-proof power converter



41875

LEXUS / TOYOTA

LX 470 (w/ factory 4 flat)

2001-07

RX 300 (w/ factory 4 flat)

2001-03

Highlander (w/ factory 4 flat)

2001-03



41905

LEXUS

RX 330

2004-06

RX 350

2007-12

Includes short-proof power converter



41915

LEXUS

CT200H

2010-16

HS 250H

2010-16

Includes short-proof power converter

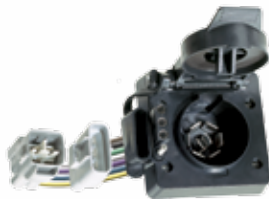

41920

LEXUS

GX460

2010-13



41925

LEXUS

LS 600H

2008-13

Includes short-proof power converter

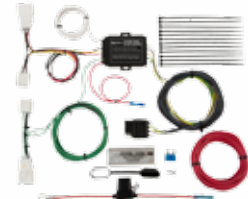

41930

LEXUS

ES 350

2007-12

Includes short-proof power converter



41935
LEXUS
 RX 400 2006-08

Includes short-proof power converter

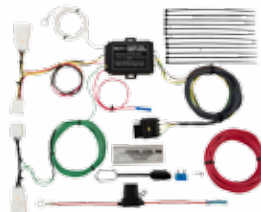

41940
LEXUS
 ES 300 2013-16
 ES 350 2013-16

Includes short-proof power converter

When testing trailer lights, make sure the trailer coupler is attached to the hitch ball. This ensures a solid ground.



41945
LEXUS
 RX 350 (w/ tow pkg) 2010-15
 RX 450 (w/ tow pkg) 2010-15

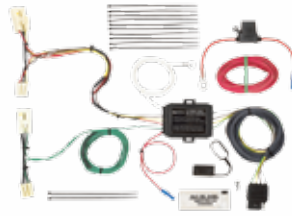

41954
SCION
 Scion XA 2004-05

Includes taillight converter

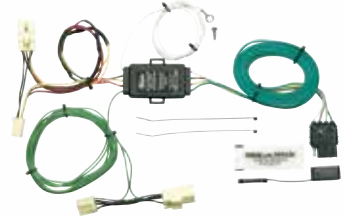

41955
SCION / TOYOTA
 Scion XB 2004-07
 Prius C 2012-16

Includes short-proof power converter



41964
SCION
 Scion TC 2011-16

Includes short-proof power converter



41965
SCION
 Scion XB 2008-10

Includes short-proof power converter

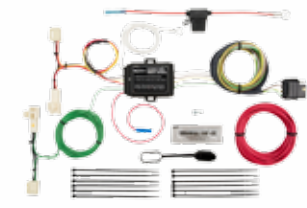

41974 **NEW 2016**
SCION / SUBARU
 Scion FR-S 2013-16
 BRZ 2013-15

Includes short-proof power converter



41975
SCION
 Scion TC 2007-10

Includes short-proof power converter

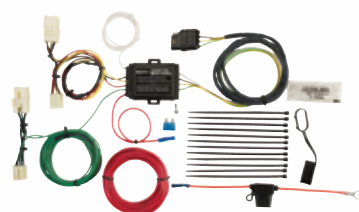

41985
SCION
 Scion XD 2008-14

Includes short-proof power converter



41995
CHRYSLER / DODGE
 Town & Country 2011-16
 Caravan / Grand Caravan 2011-16

Includes short-proof power converter

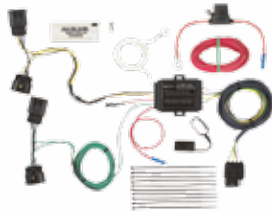

42104

DODGE

Dart 2013-16

Includes short-proof power converter

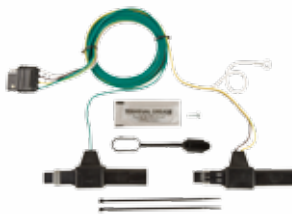

42105

DODGE

| | |
|---------------------------------|---------|
| Dakota | 1987-94 |
| Ram Pickup (all sizes) | 1987-94 |
| Ram Pickup (cab & chassis only) | 1995-02 |
| Ramcharger / Trailduster | 1988-93 |

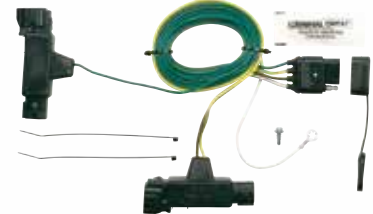

42115

DODGE

| | |
|------------------------|---------|
| Dakota | 1995-03 |
| Ram Pickup (all sizes) | 1995-01 |
| Ram Pickup 2500/3500 | 2002 |

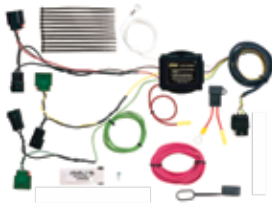

42125

DODGE / JEEP

| | |
|-----------------------|---------|
| Caliber | 2007 |
| Compass | 2007-10 |
| Patriot (w/o tow pkg) | 2007 |

Includes short-proof power converter

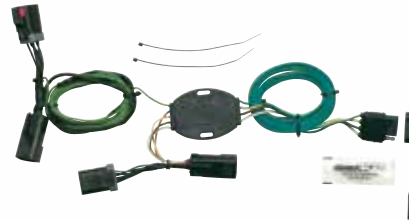

42135

DODGE

| | |
|----------------------|---------|
| Ram Pickup 1500 | 2002-06 |
| Ram Pickup 2500/3500 | 2003-06 |

Includes taillight converter



PATENTED

42145

DODGE / CHRYSLER / JEEP MULTI-TOW®

7 Blade and 4 Flat

See page 53 (Guide B)

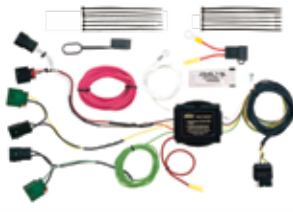

42155

DODGE

Journey 2009

Includes short-proof power converter



42165

DODGE

Charger 2011-14

Includes short-proof power converter



42175

CHRYSLER / DODGE / JEEP

| | |
|-------------------------|---------|
| Town & Country | 2008-10 |
| Caliber | 2008-12 |
| Caravan / Grand Caravan | 2008-10 |
| Durango (w/o tow pkg) | 2011-13 |
| Patriot (w/o tow pkg) | 2008-16 |

Includes short-proof power converter



PATENTED **ENDURANCE**
PROFESSIONAL GRADE

42190

DODGE / CHRYSLER / JEEP
O.E.M. QUICK INSTALL

7 Blade

See page 53 (Guide B)



42195

DODGE

Magnum 2005-08

Includes short-proof power converter

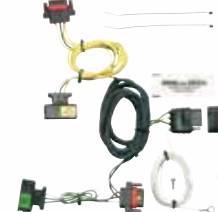

42205

CHRYSLER / DODGE / MITS / PLYMOUTH

| | |
|-------------------------|---------|
| Town & Country | 1991-95 |
| Caravan / Grand Caravan | 1991-95 |
| Dakota | 2004-11 |
| Ram Pickup 1500 | 2007-09 |
| Ram Pickup 2500/3500 | 2007-09 |
| Raider | 2006-08 |
| Voyager / Grand Voyager | 1991-95 |

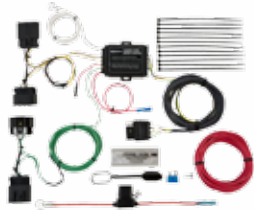

42214

DODGE

Durango (w/o tow pkg)

2014-15

Includes short-proof power converter



42215

CHRYSLER / DODGE / PLYMOUTH

| | |
|-------------------------|---------|
| Town & Country | 1996-00 |
| Caravan / Grand Caravan | 1996-00 |
| Durango | 1998-03 |
| Voyager / Grand Voyager | 1996-00 |

Includes taillight converter

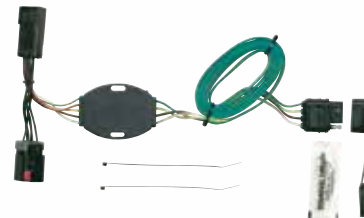

42225

CHRYSLER / DODGE / PLYMOUTH

| | |
|-------------------------|---------|
| Town & Country | 2001-03 |
| Caravan / Grand Caravan | 2001-03 |
| Voyager / Grand Voyager | 2001-03 |

Includes taillight converter



42235

CHRYSLER / DODGE

Town & Country
Caravan / Grand Caravan

2004-07
2004-07

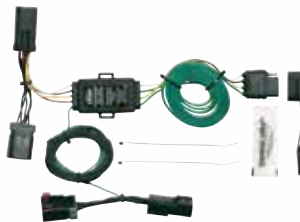

42245

CHRYSLER / DODGE

Aspen
Durango

2007-09
2004-09

Includes taillight converter



42255

DODGE

Avenger

2008-10

Includes short-proof power converter



42265

CHRYSLER

Sebring

2007-10

Includes short-proof power converter

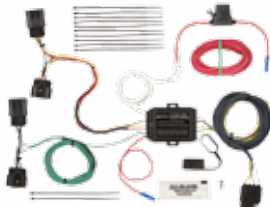

42274

CHRYSLER / DODGE

200
Avenger

2011-14
2011-14

Includes short-proof power converter



42275

CHRYSLER / DODGE

300M
Concorde
LHS
Intrepid

1999-04
1998-02
1999
1998-04

Includes short-proof power converter



42285

CHRYSLER / DODGE

300
Challenger
Charger

2005-07
2008-14
2006-10



42295

CHRYSLER

300
300C

2008-09
2005-09

Includes short-proof power converter

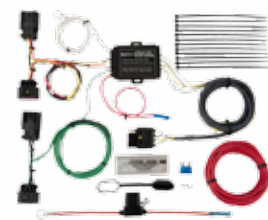

42304

DODGE / RAM

Ram Promaster

2014-16

Includes short-proof power converter

Kits are equipped with O.E.M. connectors for a perfect, weather-tight fit

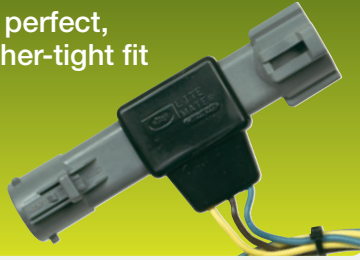

42305
DODGE
Ram Van 1993-98



42315
DODGE
Ram Van 1999-00



42345
MITSUBISHI
Outlander 2003-06

Includes short-proof power converter



42355
MITSUBISHI
Outlander 2007-12

Includes short-proof power converter



42365
MITSUBISHI
Montero Sport 2004-05

Includes short-proof power converter



42375
MITSUBISHI
Endeavor 2003-12

Includes short-proof power converter

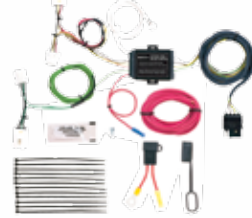

42385
MITSUBISHI
Outlander Sport (w/ LED's) 2011-15

Includes short-proof power converter



42415
CHRYSLER
Pacifica 2004-08

Includes short-proof power converter

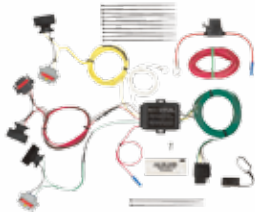

42435
CHRYSLER
PT Cruiser 2001-10

Includes short-proof power converter

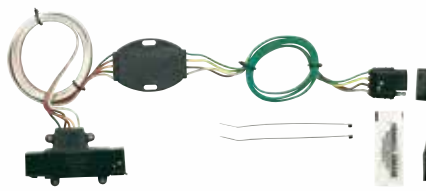

42455
JEEP
Cherokee 1991-96

Includes taillight converter



42464
JEEP
Cherokee 2014-16

Includes short-proof power converter

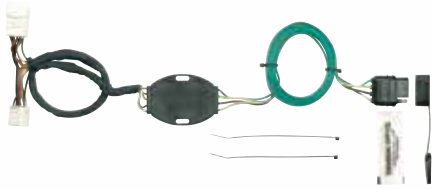

42465

JEEP

Cherokee

1997-01

Includes taillight converter

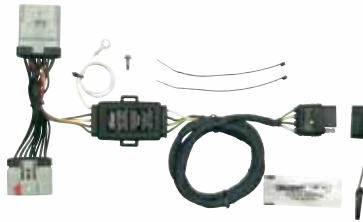

42475

JEEP

Liberty

2002-07

Includes taillight converter



42485

DODGE / JEEP

Nitro

2007-12

Liberty

2008-12

Includes short-proof power converter



42515

JEEP

Grand Cherokee (mfg. 3/94-1998)

1994-98

Includes short-proof power converter

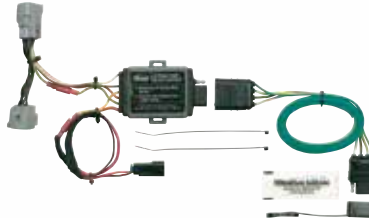

42525

JEEP

Grand Cherokee (w/ tow pkg)

1995-98

Includes short-proof power converter

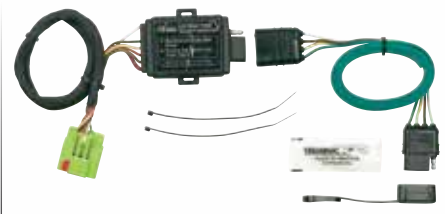

42535

JEEP

Grand Cherokee

1999-04

Includes short-proof power converter



42545

JEEP

Grand Cherokee (Early 07)

2005-07

Includes short-proof power converter



42555

JEEP

Grand Cherokee (w/o tow pkg)

2007-11



42565

JEEP

Grand Cherokee (w/ factory 4 flat)

2000-10

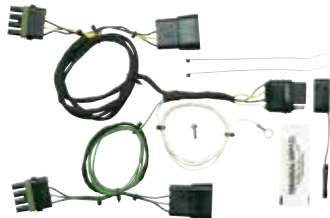

42605

JEEP

Wrangler / Renegade

1991-97



42615

JEEP

Wrangler / Renegade

1998-04

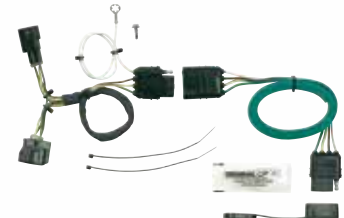

42625

JEEP

Wrangler / Renegade

2005-06



42635

JEEP

Wrangler

2007-16



42645

JEEP

Compass

2011-16

Includes short-proof power converter



42705

JEEP

Commander

2006-10

Includes short-proof power converter



43104

HONDA

Pilot

2009-11

Includes short-proof power converter



43105

ACURA / HONDA / ISUZU

| | |
|---------|---------|
| CL | 1997-03 |
| Integra | 1994-01 |
| MDX | 2001-06 |
| RL | 1996-03 |
| TL | 1996-03 |

| | |
|----------------|---------|
| Accord | 1994-02 |
| Accord (Wagon) | 1994-97 |
| CRV | 1997-06 |
| Del Sol | 1993-97 |
| Element | 2003-04 |

| | |
|----------|---------|
| Odyssey | 1995-04 |
| Pilot | 2003-08 |
| Prelude | 2001-02 |
| Ascender | 2003 |
| Oasis | 1996-98 |

Includes taillight converter



43114

HONDA

Odyssey

2011-16

Includes short-proof power converter



43115

HONDA

Odyssey

2005-10

Includes short-proof power converter

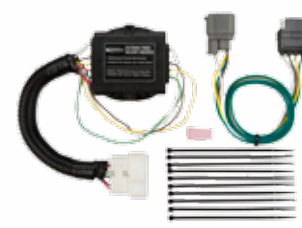

43124 **NEW 2016**

HONDA

Pilot

2012-15

Includes short-proof power converter

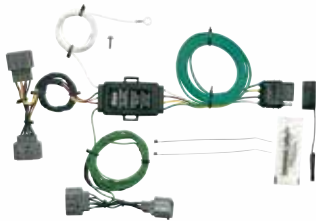

43125

HONDA

Ridgeline

2006-14

Includes taillight converter



43135

HONDA

Accord (2 door)

2003-05

Includes short-proof power converter



43145

HONDA

CRV

2007-11

Includes short-proof power converter



43155

HONDA

Accord (2 door)

2006-07

Includes taillight converter



43165

JEEP

| | | | |
|----------------------|---------|------|---------|
| Accord (2 dr & 4 dr) | 2008-16 | Fit | 2007-13 |
| Civic (4 door) | 2006-11 | CX-5 | 2013-16 |
| Civic (4 door) | 2013-16 | 3 | 2004-13 |
| Civic (2 door) | 2013-16 | 2 | 2011-14 |

Includes short-proof power converter

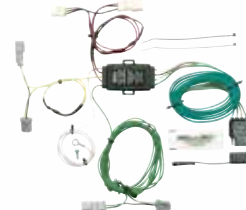

43175

HONDA

Civic (2 door)

2006-11

Includes taillight converter



43185

HONDA

Civic (All)

2012

Includes short-proof power converter



43195

ACURA / HONDA

TSX
Accord (4 door)

2006-14
2003-07

Includes short-proof power converter



43205

HONDA / ISUZU

Passport
Rodeo

1994-97
1992-97

Includes taillight converter

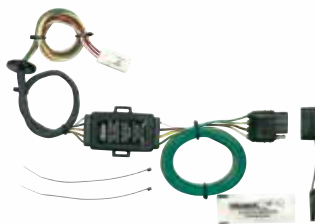

43215

HONDA / ISUZU

| | |
|----------|---------|
| Passport | 1998-04 |
| Amigo | 1998-01 |
| Axiom | 2002-04 |
| Rodeo | 1998-04 |

Includes taillight converter

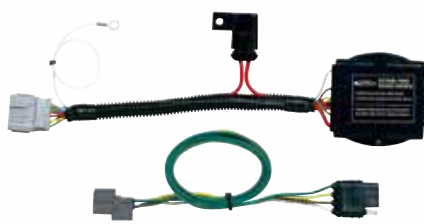

43225

HONDA

Element

2007-12

Includes short-proof power converter



43254 **NEW 2016**

ACURA

TL

2004-07

Includes short-proof power converter



43255

ACURA / ISUZU

| | |
|---------|---------|
| SLX | 1996-00 |
| Trooper | 1992-02 |

Includes taillight converter



43264

ACURA

ZDX

2010-13

Includes short-proof power converter



43265

ACURA / HONDA

RDX
Accord Crosstour

2007-12
2010-12

Includes short-proof power converter



43270 **NEW 2016**

ACURA

MDX

2014-16

Includes short-proof power converter

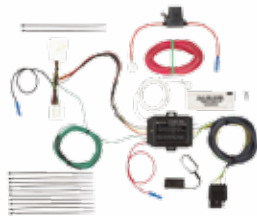

43274

HONDA

CRV

2012-15

Includes short-proof power converter



43275

ACURA

MDX

2007-13

Includes short-proof power converter

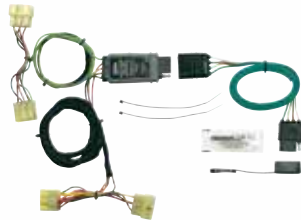

43285

ISUZU

Pickup

1989-95

Includes taillight converter

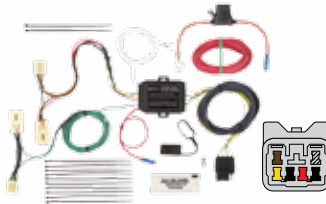

43314

TOYOTA

Prius V

2012-16

Includes short-proof power converter



43315

TOYOTA

Pickup (except T-100)
Tacoma

1984-95
1995-04

Includes taillight converter

KEEP IT CLEAN

Remember to remove all paint, dirt and rust from your ground spot before attaching your ground wire

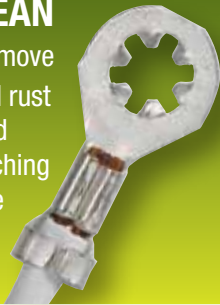

43325

TOYOTA

Sequoia (w/ tow pkg) (MT)

2005-09

Includes short-proof power converter



43335

TOYOTA

ECHO
Matrix

2000-02
2003-08

Includes short-proof power converter



43345

PONTIAC / SCION / TOYOTA

Vibe
Scion XB
Matrix

2009-12
2011-12
2009-12

Includes short-proof power converter

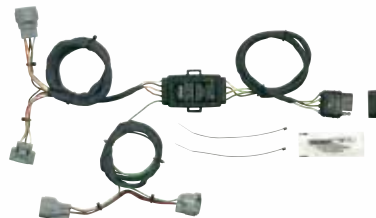

43355

TOYOTA

Tacoma (w/o tow pkg)
T-100

2005-08, 14-15
1993-98

Includes taillight converter

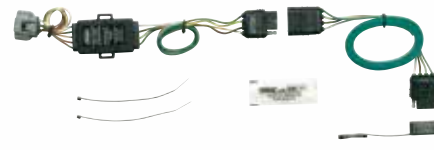

43365

TOYOTA

Tundra

2000

Includes taillight converter



43374

LEXUS / TOYOTA

GX470 (w/ tow pkg) (MT)
4-Runner (w/ tow pkg) (MT)

2003-09
2003-09



43375

TOYOTA

Tundra

2001-02

Includes short-proof power converter



43384

TOYOTA

Sequoia (w/ tow pkg) (MT)

2003-04



43385

TOYOTA

Tundra (w/ tow pkg)

2003-06



43395

TOYOTA

Tundra (w/ factory 7 blade)

2007-13

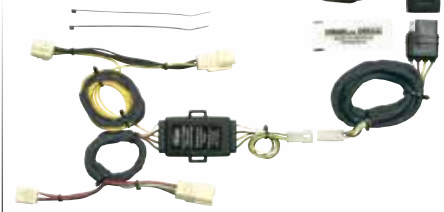

43405

LEXUS / TOYOTA

LX 450
Land Cruiser

1996-98
1991-99

Includes taillight converter

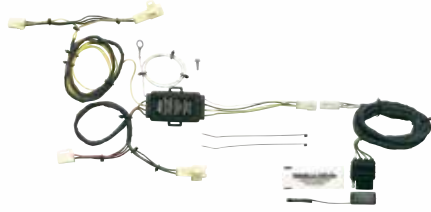

43415

TOYOTA

4-Runner

1996-02

Includes taillight converter



43425

HYUNDAI / TOYOTA

Azera
Highlander (w/o tow pkg)
Highlander (w/o LED's)

2006-11
2001-06
2007

Includes short-proof power converter



43435

TOYOTA

Sequoia

2001-02



43445

TOYOTA

RAV 4

2006-12

Includes short-proof power converter

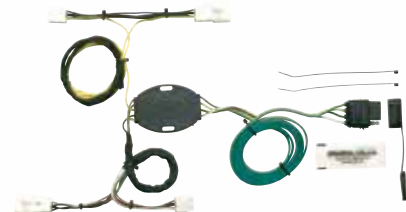

43455

TOYOTA

RAV 4

1996-00

Includes taillight converter



43465

TOYOTA

RAV 4

2001-05

Includes taillight converter

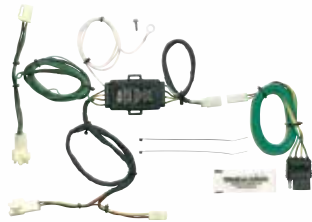

43475

TOYOTA

Sienna

1998-03

Includes taillight converter



43485

TOYOTA

Sienna

2004-10

Includes short-proof power converter



43495

TOYOTA

Sienna SE

2011-15

Includes short-proof power converter

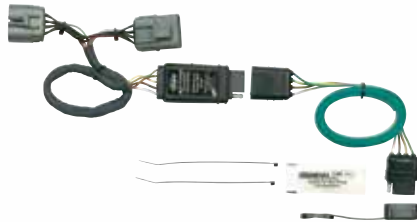

43505

NISSAN

Pickup

1986-97

Includes taillight converter

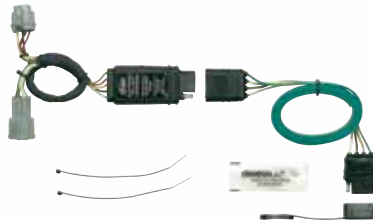

43515

NISSAN

Frontier Pickup

1998-04

Includes taillight converter



43535

NISSAN / SUZUKI

Frontier Pickup

2005-15

Equator

2009-12

Includes short-proof power converter



43565

INFINITI / NISSAN

QX4

1996-03

Altima

1997-01

Pathfinder

1996-04

Includes taillight converter

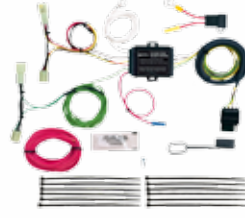

43574

SUZUKI

SX4 Sport

2008-09

Includes short-proof power converter



43575

NISSAN / SUZUKI

Frontier Pickup (w/ tow pkg)

2005-11

Pathfinder (w/ tow pkg)

2005-09

Xterra (w/ factory 4 flat)

2005-15

Equator (w/ factory 4 flat)

2009-12



43585

NISSAN

NV Van 1500 / 2500 /3500

2012-16

Includes short-proof power converter

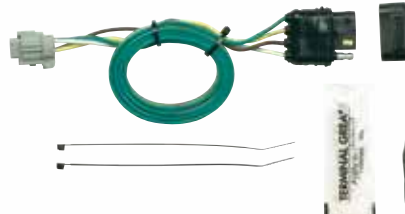

43595

NISSAN

Xterra

2000-04

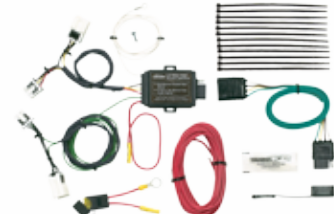

43605

NISSAN

Xterra

2005-08

Includes short-proof power converter



43624

SUBARU

Legacy

2011-16

Includes short-proof power converter



43625

NISSAN

Murano

2003-05

Includes short-proof power converter



43645

INFINITI / NISSAN

G35

2007-08

Rogue

2008-15

Includes short-proof power converter



43675

NISSAN

Altima

2005-15

Maxima

2008-16

Quest

2004-09

Sentra

2007-12

Includes short-proof power converter



43685

NISSAN

Juke

2011-15

Sentra

2013-15

Versa Note

2014-16

Includes short-proof power converter



43690 **NEW 2016**

ACURA/ NISSAN

ILX

2013-16

Pathfinder

2013-15

Includes short-proof power converter



43704

NISSAN

Versa

2012-16

Includes short-proof power converter



43705

NISSAN

Cube

2009-13

Includes taillight converter



43715

NISSAN

Versa

2007-11

Includes short-proof power converter



43720 **NEW 2016**

VOLVO

S-60

2013-17

Includes short-proof power converter

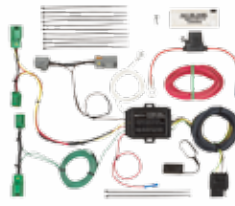

43724

VOLVO

C-70

2011-14

Includes short-proof power converter



43725

VOLVO

S-80

2007-15

Includes short-proof power converter

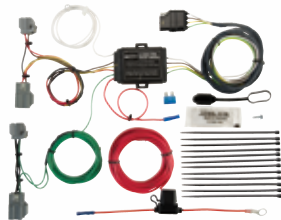

43735

VOLVO

V-70 2008-11
XC-70 2008-16

Includes short-proof power converter



43744

VOLVO

XC-60 2010-16
XC-90 2015-16

Includes short-proof power converter



43745

VOLVO

XC-90 2005-14

Includes short-proof power converter

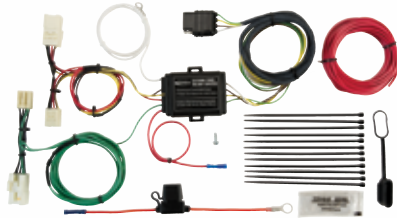

43754

HYUNDAI

Elantra GT 2013-16

Includes short-proof power converter



43755

MAZDA

Miata 1990
Pickup B-Series 1985-93

Includes taillight converter

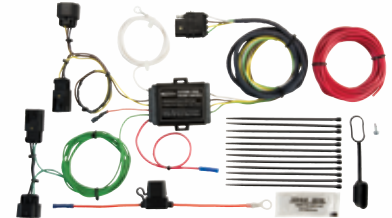

43764

VOLKSWAGEN

Routan 2011-13

Includes short-proof power converter



43765

HYUNDAI

Genesis (4 door) 2009-14

Includes short-proof power converter

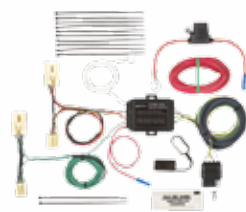

43784

HYUNDAI

Accent (4 & 5 door) 2012-15

Includes short-proof power converter



43785

HYUNDAI

Elantra 2007-10
Sonata (Except Hybrid) 2006-14

Includes taillight converter



43795

KIA

Sportage 2011-16

Includes short-proof power converter

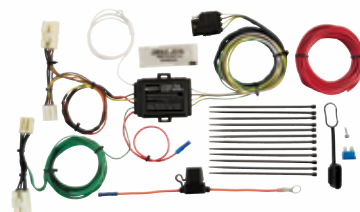

43804

HYUNDAI

Azera 2012-16

Includes short-proof power converter



43805

HYUNDAI

Santa Fe 2001-06

Includes short-proof power converter



43814

HYUNDAI

Elantra Coupe

2013-15

Includes short-proof power converter

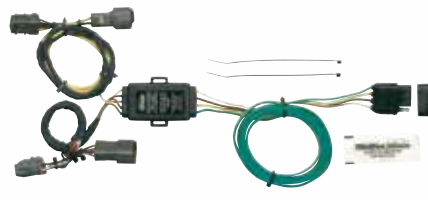

43815

HYUNDAI

Tucson

2005-09

Includes taillight converter



43820

KIA

Sorento I4, V6 (w/o tow pkg)

2014-16

Includes short-proof power converter



43824

HYUNDAI

Equus

2011-16

Genesis

2015

Includes short-proof power converter



43825

KIA

Forte

2014-16

Includes short-proof power converter

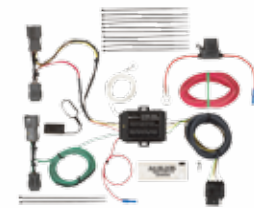

43834

HYUNDAI

Veloster

2012-16

Includes short-proof power converter



43835

HYUNDAI / KIA

Santa Fe

2007-12

Forte 4 Dr.

2010-12

Includes short-proof power converter



43855

SUBARU

B9 Tribeca

2006-16

Forester

1998-08

Impreza (Sedan)

2002-07

Legacy

2003-08

Outback

1996-08

Includes short-proof power converter



Kits come complete with dielectric terminal grease and dust covers to protect terminals from corrosion



43865

SUBARU

Forester

2009-16

Impreza WRX

2008-16

Outback Wagon

2010-14

XV Crosstrek

2013-16

Includes short-proof power converter

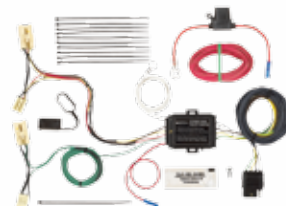

43874

HYUNDAI / KIA

Elantra (Sedan)

2011-16

Sonata (Sedan & Hybrid)

2015

K900

2015

Includes short-proof power converter

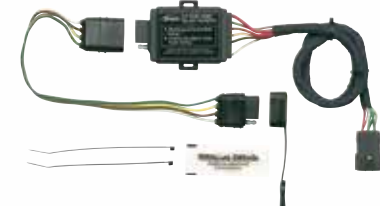

43875

SUBARU

Baja

2002-06

Includes short-proof power converter

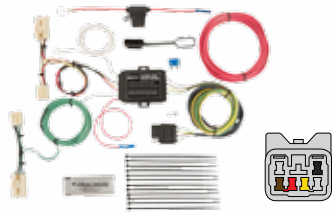

43884

SUBARU

Impreza (Sedan)

2008-16

Includes short-proof power converter

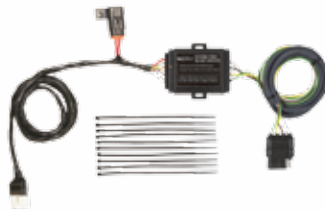

43885 **NEW 2016**

SUBARU

Outback

2015-16

Includes short-proof power converter

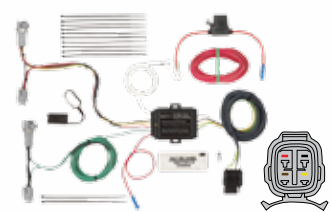

43894

SUBARU

Impreza Hatchback

2008-13

Includes short-proof power converter



43895

KIA

Forte (5 door)

2010-13

Includes short-proof power converter



43900

KIA

Cadenza

2014-16

Includes short-proof power converter



43905

KIA

Amanti

2007-09

Includes short-proof power converter



43910

LEXUS

LX 570

2008-13



43914

KIA

Sorento LX / EX 4 cyl. (No SX)

2011-13

Includes short-proof power converter



43915

KIA

Sportage

1998-02

Includes taillight converter



43924

KIA

Spectra

2004-09

Includes short-proof power converter

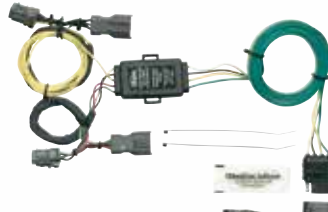

43925

KIA

Sportage

2005-06

Includes taillight converter



43934

KIA

Rio 4 door

2005-12

Includes short-proof power converter



43935

KIA

Optima

2007-08



43944

HYUNDAI / KIA

Accent
Elantra Grand Touring
Rio (5 door)

2006-11

2009-12

2005-12

Includes short-proof power converter

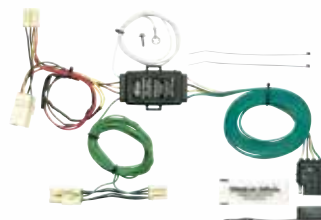

43945

KIA

Sedona

2002-05

Includes taillight converter

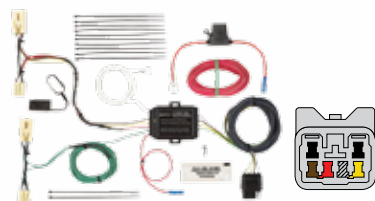

43954

KIA

Rio 4 door (Late 2012)

2012-15

Includes short-proof power converter



43955

HYUNDAI / KIA

Entourage
Sedona

2007-08

2006-15

Includes short-proof power converter



43964

KIA

Rio 5 door Hatchback (Late 2012)

2012-16

Includes short-proof power converter

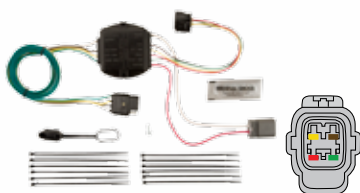

43965

HYUNDAI / KIA

Santa Fe (w/ tow pkg) 2013-16
Veracruz (w/ tow pkg) 2010-13
Sorento EX/LX V6 only (No SX) (w/ tow pkg) 2011-16

Includes short-proof power converter



43975

KIA

Rondo
Soul

2007-09

2010-16

Includes taillight converter

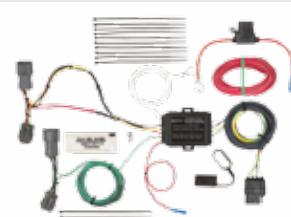

43984

HYUNDAI

Santa Fe (w/o tow pkg)

2013-16

Includes short-proof power converter

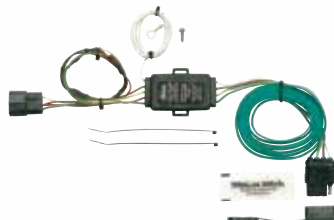

43985

KIA

Sorento

2003-06

Includes taillight converter

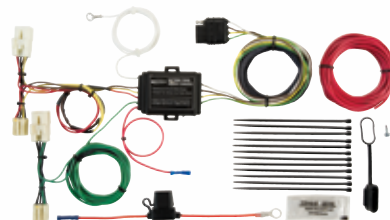

43994

HYUNDAI

Genesis Coupe (2 door)

2010-14

Includes short-proof power converter



43995

HYUNDAI

Veracruz
Sorento

2007-09

2007-09

Includes short-proof power converter

5TH WHEEL INSTALLATION MADE EASY

Our wiring kits easily route towing electrical functions into the truck bed for 5th wheel or gooseneck trailers, and still retain electrical functions at the rear of the vehicle.

ENDURANCE[™]
PROFESSIONAL GRADE



PATENTED

41157 / 41151 (Bulk, 5pk)
5TH WHEEL WIRING KIT - Length, 8 feet

CHEVY / GMC / FORD / RAM / DODGE / NISSAN / TOYOTA

| | | | | | |
|----------------|---------|-------------|---------|-----------------------|---------|
| Silverado 1500 | 2003-16 | F-350 | 2008-16 | Ram 1500 (w/ tow pkg) | 2010-16 |
| Silverado 2500 | 1999-16 | Sierra 1500 | 2003-16 | Ram 2500 (w/ tow pkg) | 2010-16 |
| Silverado 3500 | 1999-16 | Sierra 2500 | 1999-16 | Ram 2500 (w/ tow pkg) | 2010-16 |
| F-150 | 2008-16 | Sierra 3500 | 1999-16 | Tundra | 2014-16 |
| F-250 | 2008-16 | Titan | 2004-16 | | |

THE HOPKINS[®] ADVANTAGE

PLUG-IN SIMPLE![®]

Reinforced 90° angle helps install easily in hard to reach places



EXACT O.E.M. FIT

Our O.E.M. connectors perfectly match the tow vehicle



MAXIMUM DURABILITY

Each kit includes an Endurance[™] 7 blade connector and protected wires



5TH WHEEL WIRING KITS



40147

PATENTED

FORD

F-150
F-150 (Old style)
F-250 Lt Duty (11/97-2001)

1997-03
2004
1997-01



40157

PATENTED

FORD

F-250 Heavy-Duty
F-350

1999-01
1999-01



40167

PATENTED

FORD

F-250
F-350

2002-04
2002-04



40177

PATENTED

FORD

F-150 (New Style)

2004



42137

PATENTED

FORD

Ram 1500 (w/ factory 7 Blade)
Ram 2500 (w/ factory 7 Blade)
Ram 3500 (w/ factory 7 Blade)

2000-09
2000-09
2000-09



43397

PATENTED

TOYOTA

Tundra

2007-13

DINGHY TOWING SIMPLIFIED

Hopkins® RV towing products provide a comprehensive line that keeps the RV connected. Both Universal and Plug-In Simple!® applications are available to better serve consumer needs.



THE HOPKINS® ADVANTAGE

ENDURANCE™ ADAPTERS

Maximum durability and a flexible reach with industry's best 3-year warranty



STRAIGHT WIRE ADAPTERS

Provides a flexible reach with heavy duty connectors and cable



DINGHY TOWING



PLUG-IN SIMPLE!® DIODES

Exact O.E.M. fit connectors perfectly match the towed vehicle



TRADITIONAL DIODES

Offers both innovative and traditional splice in solutions



RV ADAPTERS

Flat towing the dinghy is one of the most convenient methods of towing a vehicle behind the motorhome. These adapters provide a heavy duty, flexible cord that connect the RV to the towed vehicle.



47054

Endurance™ Flex-Coil™ 7 Blade to 6 Round with Nite-Glow™ Kit (center pin electric brake)

- Nite-Glow™ illuminates on taillight function verifying continuity
- Stretches to 8 feet
- Easy-grip, heavy-duty connectors with heavy-duty cable



47053

Endurance™ Flex-Coil™ 7 Blade to 6 Round with Nite-Glow™ (center pin electric brake)

- Nite-Glow™ illuminates on taillight function verifying continuity
- Stretches to 8 feet
- Easy-grip, heavy-duty connectors with heavy-duty cable

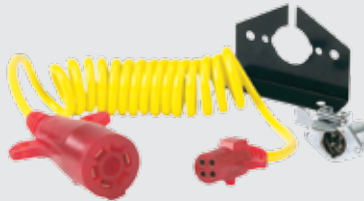

47044

Endurance™ Flex-Coil™ 7 Blade to 4 Round with Nite-Glow™ Kit

- Nite-Glow™ illuminates on taillight function verifying continuity
- Stretches to 8 feet
- Easy-grip, heavy-duty connectors with heavy-duty cable



47043

Endurance™ Flex-Coil™ 7 Blade to 4 Round with Nite-Glow™

- Nite-Glow™ illuminates on taillight function verifying continuity
- Stretches to 8 feet
- Easy-grip, heavy-duty connectors with heavy-duty cable



47057

Straight Wire 7 Blade to 6 Round Kit
(6 Round center pin electric brake)

- Length, 8 feet
 - Easy-grip, heavy-duty connectors with heavy-duty cable
- (Special order only)



47047

Straight Wire 7 Blade to 4 Round Kit

- Length, 8 feet
 - Easy-grip, heavy-duty connectors with heavy-duty cable
- (Special order only)



47056

Endurance™ Flex-Coil™ 6 Round to 6 Round with Nite-Glow™ Kit

- Nite-Glow™ illuminates on taillight function verifying continuity
- Stretches to 8 feet
- Easy-grip, heavy-duty connectors with heavy-duty cable



47055

Endurance™ Flex-Coil™ 6 Round to 6 Round with Nite-Glow™

- Nite-Glow™ illuminates on taillight function verifying continuity
- Stretches to 8 feet
- Easy-grip, heavy-duty connectors with heavy-duty cable

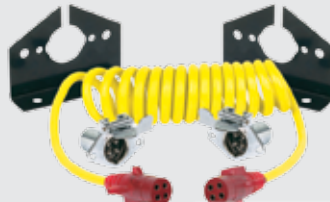

47046

Endurance™ Flex-Coil™ 4 Round to 4 Round with Nite-Glow™ Kit

- Nite-Glow™ illuminates on taillight function verifying continuity
- Stretches to 8 feet
- Easy-grip, heavy-duty connectors with heavy-duty cable



47045

Endurance™ Flex-Coil™ 4 Round to 4 Round with Nite-Glow™

- Nite-Glow™ illuminates on taillight function verifying continuity
- Stretches to 8 feet
- Easy-grip, heavy-duty connectors with heavy-duty cable

PLUG-IN SIMPLE![®] DIODES

Hopkins[®] Plug-In Simple![®] wiring kits incorporate vehicle specific harnesses and the necessary diodes to operate the tail, brake and turn light functions needed for towed vehicles. Hopkins[®] has developed a wide range of towed vehicle wiring kits for the most popular towed vehicles.



56202 Towed Vehicle Wiring Kit

- Exact O.E.M fit connectors create a perfect weather tight fit
- Plug-In Simple![®] connectors make installation quick and easy
- Includes dielectric grease, dust covers and mounting brackets

COMPLETE VEHICLE LISTING

| | MAKE / MODEL | YEAR | PART # | | MAKE / MODEL | YEAR | PART # | | MAKE / MODEL | YEAR | PART # |
|-------------------------|--------------------------------|---------|------------|---|----------------------|-------------------------------|---------|-------------------------------|--------------------------------------|---------|--------|
| BUICK / CHEVROLET / GMC | Cobalt / SS (2 door) | 2005-10 | 56100 | CADILLAC / FORD / LINCOLN / PONTIAC / ISUZU | Escape | 2008-12 | 56000 | HONDA / JEEP / MAZDA / SATURN | CR-V | 2007-11 | 56300 |
| | Colbolt Sport (2 dr) | 2008-10 | | | Edge, MKX | 2007-10 | | | Fit | 2009-13 | 56302 |
| | HHR | 2006-10 | | | Ranger Pickup | 2011 | | | CR-V | 2012-15 | 56304 |
| | HHR Sport | 2008-10 | Ranger STX | | 2005-11 | Wrangler / Renegade | | | 1998-06 | 56202 | |
| | Avalanche | 2002-06 | F-150 | | 2009-14 | Wrangler Renegade (w/tow pkg) | | | 2004-06 | | |
| | Silverado, Sierra | 2003-13 | 56101 | | Edge | 2011-13 | 56001 | | Wrangler | 2007-16 | 56200 |
| | Tahoe, Suburban | 2003-06 | 56102 | | MKX | 2011-16 | 56002 | | Liberty | 2002-07 | 56203 |
| | Avalanche (4 pin) | 2007-13 | | | Ranger | 1998-99 | 56003 | | Liberty (w/tow pkg) | 2004-07 | |
| | Tahoe, Suburban, Yukon (4 pin) | 2007-14 | 56103 | | Ranger (w/tow pkg) | 2000-09 | 56004 | | Liberty | 2008-12 | 56204 |
| | Avalanche (5 pin) | 2007-13 | | | Ranger (without STX) | 2000-10 | 56005 | | Liberty (w/tow pkg) | 2008-10 | |
| | Tahoe, Suburban, Yukon (5 pin) | 2007-14 | 56104 | | F-150 | 2000-08 | 56007 | | Commander | 2006-10 | 56205 |
| | Avalanche (6 pin) | 2007-13 | | | Mark LT | 2006-08 | 56008 | | Grand Cherokee (Early 2007) | 2005-07 | 56206 |
| | Tahoe, Suburban, Yukon (6 pin) | 2007-14 | 56106 | | Focus (4 door) | 2012-16 | 56007 | | Grand Cherokee (with factory 4 flat) | 2007-10 | 56207 |
| | Enclave | 2008-12 | | | Focus (5 door) | 2012-16 | 56008 | | Grand Cherokee (w/ tow pkg) | 2007-10 | |
| | Malibu (except LTZ) | 2008-12 | 56107 | | G5, G5 GT | 2007-10 | 56100 | | Grand Cherokee (w/o tow pkg) | 2007-11 | |
| | Traverse | 2009-12 | | | Persuit | 2005-10 | 56101 | | Grand Cherokee (w/o tow pkg) | 2007-11 | |
| | Taverse (w/ tow pkg) | 2010-12 | 56108 | | Escalade | 2002-06 | 56101 | | Tribute | 2008-11 | 56000 |
| | Acadia | 2008-12 | | | Escalade | 2007-14 | 56105 | | B-Series Pickup | 1998-09 | 56003 |
| Equinox, Terrain | 2010-16 | 56109 | I-350 | 2004-11 | 56109 | Outlook | 2007-10 | 56301 | | | |
| Colorado, Canyon | 2004-12 | | | | | Vue | 2008-10 | 56303 | | | |

TRADITIONAL SPLICE-IN DIODES

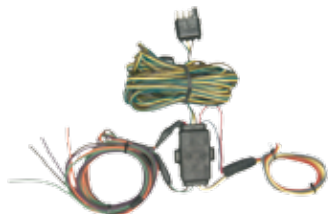

55999 Universal Towed Vehicle Wiring Kit

- Includes diode pack for proper taillight and turn signal power
- Includes dielectric grease, dust covers and mounting brackets
- 5.0 Amp capacity



48955 / 43024 (Bulk, 50 pk) Traditional Diodes

- Includes 4 diodes and 12 wire connectors
- 3 Amp capacity

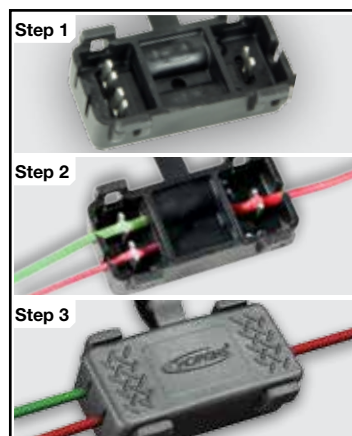

56305 (4 pk) / 56306 (1 pk) / 56307 (Bulk, 25 pk) Quick-Lock Diode™

- Saves installation time over traditional diode blocks
- Integrated quick-splice
- 5.0 Amp capacity
- Enhanced weather proofing (grease packet included)

LEVELS ABOVE THE REST.

Hopkins® has provided high-quality RV and multi-purpose levels for over 40 years. This experience has enabled us to provide the highest quality vials for years of trouble-free use.

Our levels are 100% tested, utilize high-impact plastic and easy-to-read bubbles and markings for clearly indicating level.

BECAUSE THE WORLD ISN'T FLAT™

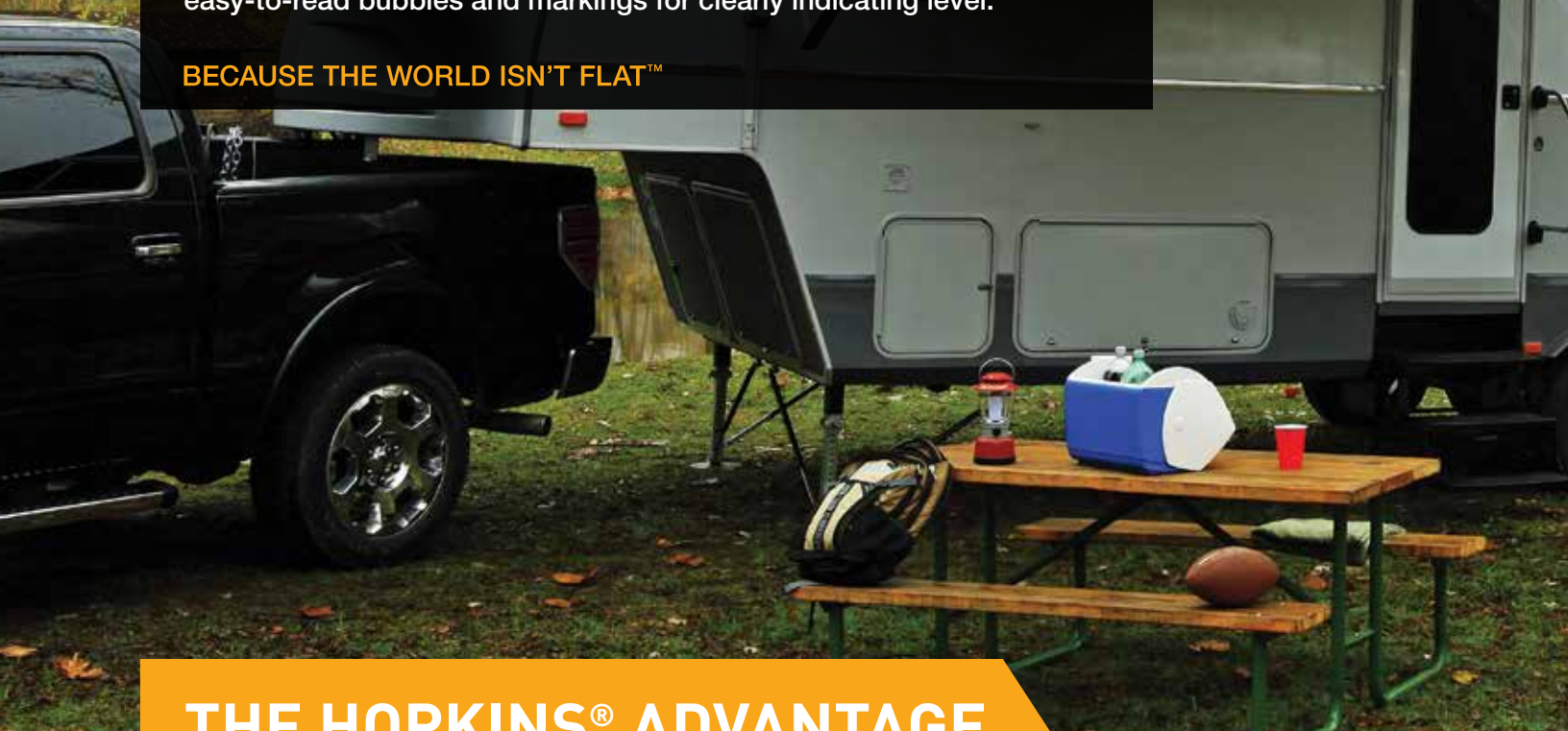

THE HOPKINS® ADVANTAGE

NEVER FADE™ INNOVATION

Made with a clear, reflective solution means harsh UV light cannot fade these levels



LARGEST SELECTION

Years of research and insight has made us the full-line supplier of RV and multipurpose levels





REFLECTIVE VIALS

Bubble vials are easily seen from a distance



TROUBLE-FREE USE

High-impact plastic and easy-to-read markings last for many years



NO FADING, EVER!

PERFORMANCE BREAKTHROUGH!

Unlike traditional green levels that fade to clear due to UV penetration, Never Fade™ levels maintain their crystal clear performance for years. A small idea with huge benefits! This new technology is available in six of the most popular levels.



08526
Two-Way Graduated Never Fade™ Level

- Takes the guesswork out of RV leveling
- Markings indicate number of inches required to raise or lower trailer or vehicle
- Optional screw holes or self sticking adhesive back
- 2 pack



03926
Two-Way Never Fade™ Stick-On Level

- Self-sticking adhesive back
- See plumb and level from a distance
- 2 pack



09916
Two-Way Never Fade™ Reflective Level

- Reflective vial technology
- Easily see plumb and level from a distance
- Permanent screw mount or adhesive back
- 2 pack



09516
Three-Way Never Fade™ Level

- Indicates level three ways: horizontal, vertical and surface
- Easily see plumb, level and plane from a distance
- Multiple leveling uses: shop equipment, picture frames, gaming tables, etc.



04026
Rear-view Never Fade™ Level (plastic)

- Levels travel trailer or fifth wheel from the driver's seat
- Mounts on front of trailer
- Easily seen from rear view mirror
- Indicates side-to-side leveling and front to back



09815
BullsEye Never Fade™ Surface Level

- Multiple leveling uses: RV appliances, power jacks, jack stands, etc.
- Optional screw holes for permanent mounting
- Easily readable vial bubble

HELP BOOST SALES!

Levels are one of those products that people need, but won't go out of their way to look for. Make it easy for them with our counter display. Put our levels out in the open, making them easy to find, and a great impulse buy to boost your sales.



08540
Never Fade™ Levels Counter Display

- 4 Pieces 04026 Rear-View Level
- 12 Pieces 08526 Two-Way Graduated Level
- 12 Pieces 03926 Two-Way Stick on Level
- 12 Pieces 09516 Three-Way Level
- Dimensions: H-26 in. W-13 in. D-8 in.



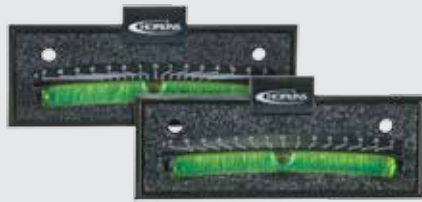

08525
Two-Way Graduated RV Level

- Takes the guesswork out of RV leveling
- Markings indicate number of inches required to raise or lower trailer or vehicle
- Optional screw holes or self sticking adhesive back
- 2 pack



09615
Cross-Check Level

- Front-to-back or side-to-side leveling
- Built in magnet for hands-free leveling
- Optional screw holes for permanent mounting on trailer hitch



09715
Hitch Level

- Pointer indicates number of inches required for adjustment
- Permanently mounts to trailer tongue
- Front-to-back or side-to-side leveling
- Includes weatherproofing cap



04025
Rear-view Level (plastic)

- Levels trailer or fifth wheel from the driver's seat
- Mounts on front of trailer
- Easily seen from rear view mirror
- Indicates side-to-side leveling and front to back

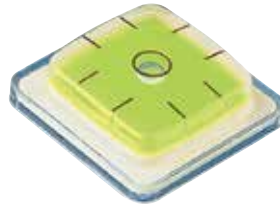

09515
Three-Way Level

- Indicates level three ways: horizontal, vertical and surface
- Easy-to-see reflective bubble
- Multiple leveling uses: shop equipment, picture frames, gaming tables, etc.



09528
Surface Level Bowl Merchandiser

- 72 Pieces
- Dimensions: H-9.5 in. W-7.25 in. D-7.25 in.



09915
Two-Way Reflective Level

- Reflective vial technology
- Level indicator is easily seen from a distance
- Red indicates not level
- Permanent screw mount or adhesive back
- 2 pack



09025
Screw-On Levels

- Screw holes for permanent mounting
- Adhesive backing for easy positioning
- 2 pack



03925
Two-Way Stick-On Level

- Self-sticking adhesive back
- Easily readable vial bubble
- 2 pack



05515
Level+Plus™ (with memory)

- Front-to-back or side-to-side leveling
- Markings indicate number of inches required to raise or lower trailer or vehicle
- Memory feature remembers hitch height when reconnecting tow vehicle
- No more jumping in and out of the truck



04115
Rear-View Level (metal)

- Levels trailer or fifth wheel from the driver's seat
- Mounts on front of trailer
- Easily seen from rear view mirror
- Indicates side-to-side leveling and front to back



02925
Decorative RV Levels

- Popular eagle design with 5 inch wing span
- Self-sticking adhesive back
- 2 pack

VEHICLE LOOKUP GUIDE

This convenient guide will help determine which applications fit any vehicle. Find your vehicle to know exactly what you need for towing, being towed or just backing up.

| Make | Model | Year | Plug-In Simple! [®] Vehicle Specific Wiring Kit | Est. Install Time Hours | Universal | 5th Wheel Kits | Brake Control Connectors | Towed Vehicle Kits | Plug-In Simple! [®] Camera |
|-----------------------|--------------------------|---------|--|----------------------------------|-----------------|----------------------|--------------------------------|--------------------------|---|
| ACURA | CL | 1997-03 | 43105 | 1 | Converter | | | | |
| | Integra | 1986-93 | N/A | | Converter | | | | |
| | Integra | 1994-01 | 43105 | 1 | Converter | | | | |
| | ILX | 2013-16 | 43690 | 1.5 | Power Converter | | | | |
| | Legend / RL | 1986-95 | N/A | | Power Converter | | | | |
| | NSX / NSX-T | 1991-00 | N/A | | Power Converter | | | | |
| | MDX | 2001-06 | 43105 | 1 | Converter | | | | |
| | MDX | 2007-13 | 43275 | 1.5 | Power Converter | | | | |
| | MDX | 2014-16 | 43270 | 1.5 | See Dealer | | | | |
| | RDX | 2007-12 | 43265 | 1.5 | Power Converter | | | | |
| | RDX | 2013-15 | N/A | | Power Converter | | | | |
| | RL | 1996-03 | 43105 | 1 | Converter | | | | |
| | RL | 2004-05 | N/A | | Converter | | | | |
| | RL | 2006-10 | N/A | | Power Converter | | | | |
| | RLX | 2014-15 | N/A | | Power Converter | | | | |
| | RSX | 2002-07 | N/A | | Power Converter | | | | |
| | SLX | 1996-00 | 43255 | 1 | Converter | | | | |
| | TL | 1996-03 | 43105 | 1 | Converter | | | | |
| | TL | 2004-07 | 43254 | 1.5 | Power Converter | | | | |
| | TL | 2008-14 | N/A | | Power Converter | | | | |
| TSX | 2006-11 | 43195 | 1.5 | Power Converter | | | | | |
| TSX (Sedan) | 2011-14 | 43195 | 1.5 | Power Converter | | | | | |
| TSX (Wagon) | 2011-14 | N/A | | Power Converter | | | | | |
| Vigor | 1992-94 | N/A | | Power Converter | | | | | |
| ZDX | 2010-13 | 43264 | 1.5 | Power Converter | | | | | |
| AMC | Alliance | 1983-87 | N/A | | Converter | | | | |
| | Concord | 1983-87 | N/A | | Converter | | | | |
| AUDI | A3 | 2006-08 | N/A | | See Dealer | | | | |
| | A3 | 2009-10 | N/A | | Power Converter | | | | |
| | A4 | 1996-08 | N/A | | Power Converter | | | | |
| | A4 | 2009-15 | N/A | | See Dealer | | | | |
| | A4 Avant Wagon | 2015 | N/A | | See Dealer | | | | |
| | A5 | 2008-14 | N/A | | See Dealer | | | | |
| | A6 | 1995-97 | N/A | | Power Converter | | | | |
| | A6 | 1998-04 | N/A | | Power Converter | | | | |
| | A6 | 2005-08 | N/A | | Power Converter | | | | |
| | A6 | 2009-15 | N/A | | See Dealer | | | | |
| | A7 | 2012-15 | N/A | | See Dealer | | | | |
| | A8 | 1997-15 | N/A | | Power Converter | | | | |
| | Allroad | 2004-06 | N/A | | Power Converter | | | | |
| | Q3 (with tow package) | 2009-15 | 40940, 40950, 40955, 40965, 40974, 40975 | 0.5 | See Dealer | | | | |
| | Q3 (without tow package) | 2009-15 | 41155 | 0.5 | See Dealer | | | | |
| | Q5 (without tow package) | 2009-10 | N/A | | See Dealer | | | | |
| | Q5 (with tow package) | 2009-14 | 40940, 40950, 40955, 40965, 40975 | 0.5 | 7 Blade | | | | |
| | Q5 (with tow package) | 2009-14 | 41155 | 0.5 | 4 Flat | | | | |
| | Q7 (without tow package) | 2007-15 | N/A | | See Dealer | | | | |
| | Q7 (with tow package) | 2007-15 | 40940, 40950, 40955, 40965, 40975 | 0.5 | 7 Blade | | | | |
| Q7 (with tow package) | 2007-15 | 41155 | 0.5 | 4 Flat | | | | | |
| R8 | 2008-10 | N/A | | See Dealer | | | | | |
| TT | 2000-06 | N/A | | Power Converter | | | | | |
| TT | 2008-10 | N/A | | See Dealer | | | | | |

| Make | Model | Year | Plug-In Simple! [®] Vehicle Specific Wiring Kit | Est. Install Time Hours | Universal | 5th Wheel Kits | Brake Control Connectors | Towed Vehicle Kits | Plug-In Simple! [®] Camera |
|-----------------|-------------------------------|---------|--|----------------------------------|-----------------|----------------------|--------------------------------|--------------------------|---|
| BMW | All Models | 1985-04 | N/A | | Power Converter | | | | |
| | 1 Series | 2011-14 | N/A | | Power Converter | | | | |
| | 3 Series | 2004-15 | N/A | | Power Converter | | | | |
| | 4 Series | 2014-15 | N/A | | See Dealer | | | | |
| | 5 Series | 2011-15 | N/A | | Power Converter | | | | |
| | 525i | 2005-09 | N/A | | Power Converter | | | | |
| | 530i | 2006-07 | N/A | | Power Converter | | | | |
| | 550 | 2006-10 | N/A | | Power Converter | | | | |
| | 750i | 2006-08 | N/A | | Power Converter | | | | |
| | 545i | 2005 | N/A | | Power Converter | | | | |
| | 6 Series | 2012-14 | N/A | | Power Converter | | | | |
| | 650i | 2006 | N/A | | Power Converter | | | | |
| | 7 Series | 2011-14 | N/A | | Power Converter | | | | |
| | M3 | 2006 | N/A | | Power Converter | | | | |
| | M6 | 2012-15 | N/A | | Power Converter | | | | |
| | X1 | 2013-14 | N/A | | Power Converter | | | | |
| | X3 | 2004-14 | N/A | | See Dealer | | | | |
| | X5 | 2004-10 | N/A | | See Dealer | | | | |
| | X6 | 2015 | N/A | | See Dealer | | | | |
| | Z4 | 2011-13 | N/A | | Power Converter | | | | |
| Z4 | 2014 | N/A | | Power Converter | | | | | |
| BUICK | Apollo | 1975 | N/A | | 4 Flat | | | | |
| | Century | 1975-77 | N/A | | 4 Flat | | | | |
| | Century | 1978-81 | N/A | | Converter | | | | |
| | Century | 1982-05 | N/A | | 4 Flat | | | | |
| | Electra | 1971-84 | N/A | | 4 Flat | | | | |
| | Electra | 1985-96 | N/A | | Converter | | | | |
| | Enclave | 2008-12 | 41615 | 1.5 | Power Converter | | 47875 | 56106 | |
| | Enclave (with tow package) | 2008-12 | 40940, 40950, 40955, 40965, 40975 | 0.5 | 7 Blade | | 47875 | 56106 | |
| | Enclave (with tow package) | 2008-12 | 41155 | 0.5 | 4 Flat | | 47875 | 56106 | |
| | Enclave (with tow package) | 2013-16 | 40920, 40930, 40940, 40950 40955, 40965, 40975 | 0.5 | 7 Blade | | 47875 | | |
| | Enclave (with tow package) | 2013-16 | 41155 | 0.5 | 4 Flat | | 47875 | | |
| | Enclave (without tow package) | 2013-16 | 41310 | | Power Converter | | 47875 | | |
| | Encore | 2013-16 | 41300 | 1.5 | Power Converter | | | | |
| | Estate | 1971-96 | N/A | | 4 Flat | | | | |
| | LaCrosse | 2005-09 | 41385 | 1 | 4 Flat | | | | |
| | LaCrosse | 2010-16 | 41315 | 1.5 | Power Converter | | | | |
| | LeSabre | 1975-85 | N/A | | 4 Flat | | | | |
| | LeSabre | 1986-89 | N/A | | Converter | | | | |
| | LeSabre | 1990-05 | N/A | | 4 Flat | | | | |
| | Lucerne | 2006-11 | 41395 | 1 | 4 Flat | | | | |
| | Park Ave | 1971-84 | N/A | | 4 Flat | | | | |
| | Park Ave | 1985-05 | N/A | | Converter | | | | |
| | Rainier | 2004-07 | 40920, 40930, 40940, 40950 40955, 40965, 40975 | 0.5 | 7 Blade | | | | |
| | Rainier | 2004-07 | 41155 | 0.5 | 4 Flat | | | | |
| | Regal | 1974-04 | N/A | | 4 Flat | | | | |
| | Regal | 2011-13 | 41375 | 1 | 4 Flat | | | | |
| | Regal | 2014-16 | 41384 | 1.5 | Power Converter | | | | |
| | Rendezvous | 2002-07 | 41405 | 1 | 4 Flat | | | | |
| | Riviera | 1974-85 | N/A | | Converter | | | | |
| | Riviera | 1986-98 | N/A | | Power Converter | | | | |
| | Roadmaster | 1991-96 | 41185 | 1 | 4 Flat | | | | |
| | Roadmaster Estate Wagon | 1991-96 | 41195 | 1 | 4 Flat | | | | |
| | Skyhawk | 1975-89 | N/A | | 4 Flat | | | | |
| | Skylark | 1975-97 | N/A | | 4 Flat | | | | |
| Somerset | 1985-87 | N/A | | 4 Flat | | | | | |
| Terraza | 2005-07 | 41175 | 1 | 4 Flat | | | | | |
| Verano | 2012-16 | 41374 | 1.5 | Power Converter | | | | | |
| CADILLAC | Allante | 1987-93 | N/A | | Power Converter | | | | |
| | ATS | 2013-16 | N/A | | Power Converter | | | | |
| | ATS-V | 2015-16 | N/A | | Power Converter | | | | |
| | Calais | 1974-84 | N/A | | Power Converter | | | | |
| | Catera | 1997-01 | N/A | | Power Converter | | | | |
| | Cimarron | 1982-88 | N/A | | Converter | | | | |
| | CTS | 2003-07 | 41485 | 1.5 | Power Converter | | | | |
| | CTS-V | 2004-07 | 41485 | 1.5 | Power Converter | | | | |





| Make | Model | Year | Plug-In Simple! [®] Vehicle Specific Wiring Kit | Est. Install Time Hours | Universal | 5th Wheel Kits | Brake Control Connectors | Towed Vehicle Kits | Plug-In Simple! [®] Camera |
|----------------------|----------------------------------|---------|--|----------------------------------|-----------------|----------------------|--------------------------------|--------------------------|---|
| CADILLAC | CTS, CTS-V | 2008-16 | 41495 | 1.5 | Power Converter | | | | |
| | De Ville | 1975-05 | N/A | | Power Converter | | | | |
| | DTS | 2006-10 | N/A | | Power Converter | | | | |
| | Eldorado | 1979-02 | N/A | | Power Converter | | | | |
| | ELR | 2014 | 41474 | 1.5 | Power Converter | | | | |
| | Escalade | 1999 | 41125 | 1 | 4 Flat | | | | |
| | Escalade | 2000 | 41125 | 1 | 4 Flat | | 47795 | | |
| | Escalade | 2001 | N/A | | 4 Flat | | 47795 | | |
| | Escalade | 2002-06 | 40940, 40950, 40955, 40965, 40975 | 0.5 | 7 Blade | | 47795 | 56101 | 50002 |
| | Escalade | 2002-06 | 41155 | 0.5 | 4 Flat | | 47795 | 56101 | 50002 |
| | Escalade / EXT / ESV | 2007-13 | 40940, 40950, 40955, 40965, 40975 | 0.5 | 7 Blade | | 47685 | 56105 | 50002 |
| | Escalade / EXT / ESV | 2007-13 | 41155 | 0.5 | 4 Flat | | 47685 | 56105 | 50002 |
| | Escalade / EXT / ESV | 2014 | 40920, 40930, 40940, 40950 40955, 40965, 40975 | 0.5 | 7 Blade | | | 56105 | 50002 |
| | Escalade / EXT / ESV | 2014 | 41155 | 0.5 | 4 Flat | | | 56105 | 50002 |
| | Escalade / EXT / ESV | 2015 | 40920, 40930, 40940, 40950 40955, 40965, 40975 | 0.5 | 7 Blade | | | | 50002 |
| | Escalade / EXT / ESV | 2015 | 41155 | 0.5 | 4 Flat | | | | 50002 |
| | Fleetwood | 1974-96 | N/A | | | Power Converter | | | |
| | Seville | 1975-97 | N/A | | | Power Converter | | | |
| | Seville | 1998-05 | N/A | | | Converter | | | |
| | SRX | 2004-09 | N/A | | | Power Converter | | | |
| | SRX | 2010-16 | 41475 | 1 | 4 Flat | | | | |
| STS | 2006-10 | N/A | | | Power Converter | | | | |
| XLR | 2006-09 | N/A | | | Power Converter | | | | |
| XTS | 2013-16 | N/A | | | Power Converter | | | | |
| CHEVROLET | Astro | 1985-94 | N/A | | 4 Flat | | | | |
| | Astro | 1995-05 | 41225 | 1 | 4 Flat | | | | |
| | Avalanche | 2002-06 | 40920, 40930, 40940, 40950 40955, 40965, 40975 | 0.5 | 7 Blade | | 47795 | 56101 | 50002 |
| | Avalanche | 2002-06 | 41155 | 0.5 | 4 Flat | | 47795 | | 50002 |
| | Avalanche (4 pin taillight plug) | 2007-13 | 40920, 40930, 40940, 40950 40955, 40965, 40975 | 0.5 | 7 Blade | | 47685 | 56102 | 50002 |
| | Avalanche (4 pin taillight plug) | 2007-13 | 41155 | 0.5 | 4 Flat | | 47685 | 56102 | 50002 |
| | Avalanche (5 pin taillight plug) | 2007-13 | 40920, 40930, 40940, 40950 40955, 40965, 40975 | 0.5 | 7 Blade | | 47685 | 56103 | 50002 |
| | Avalanche (5 pin taillight plug) | 2007-13 | 41155 | 0.5 | 4 Flat | | 47685 | 56103 | 50002 |
| | Avalanche (6 pin taillight plug) | 2007-13 | 40920, 40930, 40940, 40950 40955, 40965, 40975 | 0.5 | 7 Blade | | 47685 | 56104 | 50002 |
| | Avalanche (6 pin taillight plug) | 2007-13 | 41155 | 0.5 | 4 Flat | | 47685 | 56104 | 50002 |
| | Aveo Sedan | 2007-11 | 41295 | 1.5 | Power Converter | | | | |
| | Aveo Hatchback (5 door) | 2004-11 | 41415 | 1.5 | Power Converter | | | | |
| | Bel Air | 1974-75 | N/A | | | 4 Flat | | | |
| | Beretta | 1988-96 | N/A | | | 4 Flat | | | |
| | Blazer (full size) | 1973-84 | 41105 | 0.5 | 4 Flat | | | | |
| | Blazer (full size) | 1985-91 | 41115 | 0.5 | 4 Flat | | | | |
| | Blazer (full size) | 1992-94 | 41125 | 0.5 | 4 Flat | | | | |
| | Blazer | 1995-04 | 41225 | 0.5 | 4 Flat | | | | |
| | S-10 Blazer (2 door) | 1984-91 | 41205 | 0.5 | 4 Flat | | | | |
| | S-10 Blazer (2 door) | 1992-94 | 41215 | 0.5 | 4 Flat | | | | |
| | S-10 Blazer (4 door) | 1991-94 | N/A | | | 4 Flat | | | |
| | Caballero | 1978-87 | N/A | | | 4 Flat | | | |
| | Camaro | 1974-77 | N/A | | | 4 Flat | | | |
| | Camaro | 1978-02 | N/A | | | Converter | | | |
| | Camaro | 2010-11 | 41285 | 1 | 4 Flat | | | | |
| | Camaro (without LED taillights) | 2012-16 | 40495 | 1.5 | Power Converter | | | | |
| | Camaro (with LED taillights) | 2012-15 | N/A | | | Power Converter | | | |
| | Caprice | 1975-93 | N/A | | | 4 Flat | | | |
| | Caprice | 1994-96 | 41185 | 1 | 4 Flat | | | | |
| | Caprice Wagon | 1991-96 | 41195 | 1 | 4 Flat | | | | |
| | Captiva | 2012-14 | 41304 | 1.5 | Power Converter | | | | |
| | Cavalier | 1982-87 | N/A | | | Converter | | | |
| | Cavalier | 1988-05 | N/A | | | 4 Flat | | | |
| Celebrity | 1982-84 | N/A | | | Converter | | | | |
| Celebrity | 1985-90 | N/A | | | 4 Flat | | | | |
| Chevelle | 1974-77 | N/A | | | 4 Flat | | | | |
| Classic | 2005 | N/A | | | Converter | | | | |
| Cobalt / SS (2 door) | 2005-10 | 41555 | 1 | 4 Flat | | | 56100 | | |

| Make | Model | Year | Plug-In Simple! [®] Vehicle Specific Wiring Kit | Est. Install Time Hours | Universal | 5th Wheel Kits | Brake Control Connectors | Towed Vehicle Kits | Plug-In Simple! [®] Camera |
|--------------------------------------|--------------------------------|---|--|----------------------------------|-----------------|----------------------|--------------------------------|--------------------------|---|
| CHEVROLET | Cobalt Sport (2 door) | 2008-10 | 41555 | 1 | 4 Flat | | | 56100 | |
| | Cobalt / SS (4 door) | 2005-10 | 41565 | 1 | 4 Flat | | | | |
| | Cobalt Sport (4 door) | 2008-10 | 41565 | 1 | 4 Flat | | | | |
| | Colorado | 2004-07 | 41165 | 1.5 | Power Converter | | | 56109 | |
| | Colorado (without tow package) | 2008-12 | 41165 | 1.5 | Power Converter | | | 56109 | |
| | Colorado (with tow package) | 2008-12 | 40940, 40950, 40955, 40965, 40975 | 0.5 | 7 Blade | | | 56109 | 50002 |
| | Colorado (with tow package) | 2008-12 | 41155 | 0.5 | 4 Flat | | | 56109 | 50002 |
| | Colorado (without tow package) | 2015-16 | 41164 | 1.5 | Power Converter | | | | |
| | Colorado (with tow harness) | 2015-16 | 41144 | 1 | 7 Blade | | | | |
| | Colorado (with tow package) | 2015-16 | 40940, 40950, 40955, 40965, 40975 | 0.5 | 7 Blade | | | | 50002 |
| | Colorado (with tow package) | 2015-16 | 41155 | 0.5 | 4 Flat | | | | 50002 |
| | Corsica | 1988-96 | N/A | | 4 Flat | | | | |
| | Corvette | 1975-01 | N/A | | Power Converter | | | | |
| | Corvette | 2003-04 | N/A | | 4 Flat | | | | |
| | Corvette | 2005-12 | 40495 | 1.5 | Power Converter | | | | |
| | Corvette | 2014-16 | 41575 | 1.5 | Power Converter | | | | |
| | Cruze | 2011-16 | 41435 | 1.5 | Power Converter | | | | |
| | El Camino | 1975-87 | N/A | | 4 Flat | | | | |
| | Equinox | 2004-06 | 41235 | 1.5 | Power Converter | | | | |
| | Equinox | 2007-09 | 41265 | 1 | 4 Flat | | | | |
| | Equinox | 2010-16 | 41275 | 1 | 4 Flat | | | 56108 | |
| | Express Van | 1996-99 | 41325 | 1 | Converter | | | | |
| | Express Van | 2000-02 | 41335 | 1 | Converter | | | | |
| | Express Van | 2003-16 | 41345 | 1.5 | Power Converter | | | | |
| | Express Van (with tow package) | 2008-16 | 40940, 40950, 40955, 40965, 40975 | 0.5 | 7 Blade | | | | |
| | Express Van (with tow package) | 2008-16 | 41155 | 0.5 | 4 Flat | | | | |
| | HHR | 2006-10 | 41555 | 1 | 4 Flat | | | 56100 | |
| | HHR Sport | 2008-10 | 41555 | 1 | 4 Flat | | | 56100 | |
| | HHR | 2011 | 41555 | 1 | 4 Flat | | | | |
| | HHR Sport | 2011 | 41555 | 1 | 4 Flat | | | | |
| | Impala | 1975-82 | N/A | | 4 Flat | | | | |
| | Impala SS | 1994-96 | 41185 | 1 | 4 Flat | | | | |
| | Impala | 2000-05 | N/A | | 4 Flat | | | | |
| | Impala | 2006-13 | 41595 | 1 | 4 Flat | | | | |
| | Impala | 2014-16 | 41434 | 1.5 | Power Converter | | | | |
| | Lumina | 1990-00 | N/A | | 4 Flat | | | | |
| | Lumina APV Van | 1990-92 | N/A | | 4 Flat | | | | |
| | Lumina APV Van | 1993-96 | 41355 | 1 | 4 Flat | | | | |
| | Malibu | 1974-83 | N/A | | 4 Flat | | | | |
| | Malibu | 1997-03 | N/A | | Converter | | | | |
| | Malibu | 2004-07 | 41605 | 1.5 | Power Converter | | | | |
| | Malibu (except LTZ) | 2008-12 | 41615 | 1.5 | Power Converter | | | 56106 | |
| | Malibu | 2013-16 | 41625 | 1.5 | PWM | | | | |
| | Metro | 1998-00 | N/A | | Power Converter | | | | |
| | Monte Carlo | 1970-88 | N/A | | 4 Flat | | | | |
| | Monte Carlo | 1995-99 | N/A | | 4 Flat | | | | |
| | Monte Carlo | 2000-06 | N/A | | Converter | | | | |
| | Monte Carlo | 2007 | N/A | | 4 Flat | | | | |
| | Monza | 1975-80 | N/A | | 4 Flat | | | | |
| | Nova | 1975-79 | N/A | | 4 Flat | | | | |
| Nova | 1985-88 | N/A | | Power Converter | | | | | |
| Prizm | 1998-02 | N/A | | Converter | | | | | |
| Pickup (full size) | 1963-67 | N/A | | 4 Flat | | | | | |
| Pickup (full size) | 1968-84 | 41105 | 0.5 | 4 Flat | | | | | |
| Pickup (full size) | 1985-87 | 41115 | 0.5 | 4 Flat | | | | | |
| Pickup (full size) | 1988-98 | 41125 | 0.5 | 4 Flat | | | | | |
| Pickup C/K (old body style) | 1999-00 | 41125 | 0.5 | 4 Flat | | | | | |
| Silverado 1500 (new body style) | 1999-02 | 41145 | 1 | 4 Flat | | | 47795 | | |
| Silverado 1500 | 2003-07 | 40920, 40930, 40940, 40950 40955, 40965, 40975 | 0.5 | 7 Blade | 41157 | 47795 | 56101 | 50002 | |
| Silverado 1500 | 2003-07 | 41155 | 0.5 | 4 Flat | 41157 | 47795 | 56101 | 50002 | |
| Silverado 1500 (new body style) | 2007-13 | 40920, 40930, 40940, 40950 40955, 40965, 40975 | 0.5 | 7 Blade | 41157 | 47685 | 56101 | 50002 | |
| Silverado 1500 (new body style) | 2007-13 | 41155 | 0.5 | 4 Flat | 41157 | 47685 | 56101 | 50002 | |
| Silverado 2500/3500 (new body style) | 1999-02 | 40920, 40930, 40940, 40950 40955, 40965, 40975 | 0.5 | 7 Blade | 41157 | 47795 | | 50002 | |
| Silverado 2500/3500 (new body style) | 1999-02 | 41155 | 0.5 | 4 Flat | 41157 | 47795 | | 50002 | |





CHEVROLET

| Make | Model | Year | Plug-In Simple! [®] Vehicle Specific Wiring Kit | Est. Install Time Hours | Universal | 5th Wheel Kits | Brake Control Connectors | Towed Vehicle Kits | Plug-In Simple! [®] Camera |
|------|---|---------|--|----------------------------------|-----------------|----------------------|--------------------------------|--------------------------|---|
| | Silverado 2500/3500 | 2003-07 | 40920, 40930, 40940, 40950, 40955, 40965, 40975 | 0.5 | 7 Blade | 41157 | 47795 | 56101 | 50002 |
| | Silverado 2500/3500 | 2003-07 | 41155 | 0.5 | 4 Flat | 41157 | 47795 | 56101 | 50002 |
| | Silverado 2500/3500 (new body style) | 2007-13 | 40920, 40930, 40940, 40950, 40955, 40965, 40975 | 0.5 | 7 Blade | 41157 | 47685 | 56101 | 50002 |
| | Silverado 2500/3500 (new body style) | 2007-13 | 41155 | 0.5 | 4 Flat | 41157 | 47685 | 56101 | 50002 |
| | Silverado 1500, 2500, 3500 | 2014-16 | 40940, 40950, 40955, 40965, 40974, 40975 | 0.5 | 7 Blade | 41157 | 53075 | | 50002 |
| | Silverado 1500, 2500, 3500 | 2014-16 | 41155 | 0.5 | 4 Flat | 41157 | 53075 | | 50002 |
| | S-10 Pickup | 1985-97 | 41115 | 0.5 | 4 Flat | | | | |
| | S-10 Pickup | 1998-04 | 41135 | 0.5 | 4 Flat | | | | |
| | Sonic (4 door) | 2012-16 | 41174 | 1.5 | PWM | | | | |
| | Sonic Hatchback | 2013-16 | 41174 | 1.5 | PWM | | | | |
| | Spark | 2013-15 | 41120 | 1.5 | Power Converter | | | | |
| | SS | 2014-16 | 41585 | 1.5 | PWM | | | | |
| | Suburban | 1973-84 | 41105 | 0.5 | 4 Flat | | | | |
| | Suburban | 1985-91 | 41115 | 0.5 | 4 Flat | | | | |
| | Suburban | 1992-99 | 41125 | 0.5 | 4 Flat | | | | |
| | Suburban | 2000-02 | 40920, 40930, 40940, 40950 40955, 40965, 40975 | 0.5 | 7 Blade | | 47795 | | 50002 |
| | Suburban | 2000-02 | 41155 | 0.5 | 4 Flat | | 47795 | | 50002 |
| | Suburban | 2003-06 | 40920, 40930, 40940, 40950 40955, 40965, 40975 | 0.5 | 7 Blade | | 47795 | 56101 | 50002 |
| | Suburban | 2003-06 | 41155 | 0.5 | 4 Flat | | 47795 | 56101 | 50002 |
| | Suburban (4 pin taillight plug) | 2007-13 | 40920, 40930, 40940, 40950 40955, 40965, 40975 | 0.5 | 7 Blade | | 47685 | 56102 | 50002 |
| | Suburban (4 pin taillight plug) | 2007-13 | 41155 | 0.5 | 4 Flat | | 47685 | 56102 | 50002 |
| | Suburban (5 pin taillight plug) | 2007-13 | 40920, 40930, 40940, 40950 40955, 40965, 40975 | 0.5 | 7 Blade | | 47685 | 56103 | 50002 |
| | Suburban (5 pin taillight plug) | 2007-13 | 41155 | 0.5 | 4 Flat | | 47685 | 56103 | 50002 |
| | Suburban (6 pin taillight plug) | 2007-13 | 40920, 40930, 40940, 40950 40955, 40965, 40975 | 0.5 | 7 Blade | | 47685 | 56104 | 50002 |
| | Suburban (6 pin taillight plug) | 2007-13 | 41155 | 0.5 | 4 Flat | | 47685 | 56104 | 50002 |
| | Suburban (4 pin taillight plug) | 2014 | 40920, 40930, 40940, 40950 40955, 40965, 40975 | 0.5 | 7 Blade | | | 56102 | 50002 |
| | Suburban (4 pin taillight plug) | 2014 | 41155 | 0.5 | 4 Flat | | | 56102 | 50002 |
| | Suburban (5 pin taillight plug) | 2014 | 40920, 40930, 40940, 40950 40955, 40965, 40975 | 0.5 | 7 Blade | | | 56103 | 50002 |
| | Suburban (5 pin taillight plug) | 2014 | 41155 | 0.5 | 4 Flat | | | 56103 | 50002 |
| | Suburban (6 pin taillight plug) | 2014 | 40920, 40930, 40940, 40950 40955, 40965, 40975 | 0.5 | 7 Blade | | | 56104 | 50002 |
| | Suburban (6 pin taillight plug) | 2014 | 41155 | 0.5 | 4 Flat | | | 56104 | 50002 |
| | Suburban (4 pin taillight plug) | 2015 | 40920, 40930, 40940, 40950 40955, 40965, 40975 | 0.5 | 7 Blade | | | | 50002 |
| | Suburban (4 pin taillight plug) | 2015 | 41155 | 0.5 | 4 Flat | | | | 50002 |
| | Suburban (5 pin taillight plug) | 2015 | 40920, 40930, 40940, 40950 40955, 40965, 40975 | 0.5 | 7 Blade | | | | 50002 |
| | Suburban (5 pin taillight plug) | 2015 | 41155 | 0.5 | 4 Flat | | | | 50002 |
| | Suburban (6 pin taillight plug) | 2015 | 40920, 40930, 40940, 40950 40955, 40965, 40975 | 0.5 | 7 Blade | | | | 50002 |
| | Suburban (6 pin taillight plug) | 2015 | 41155 | 0.5 | 4 Flat | | | | 50002 |
| | Tahoe | 1995-99 | 41125 | 0.5 | 4 Flat | | | | |
| | Tahoe | 2000-02 | 40940, 40950, 40955, 40965, 40975 | 0.5 | 7 Blade | | 47795 | | 50002 |
| | Tahoe | 2000-02 | 41155 | 0.5 | 4 Flat | | 47795 | | 50002 |
| | Tahoe | 2003-06 | 40940, 40950, 40955, 40965, 40975 | 0.5 | 7 Blade | | 47795 | 56101 | 50002 |
| | Tahoe | 2003-06 | 41155 | 0.5 | 4 Flat | | 47795 | 56101 | 50002 |
| | Tahoe (4 pin taillight plug) | 2007-13 | 40920, 40930, 40940, 40950, 40955, 40965, 40975 | 0.5 | 7 Blade | | 47685 | 56102 | 50002 |
| | Tahoe (4 pin taillight plug) | 2007-13 | 41155 | 0.5 | 4 Flat | | 47685 | 56102 | 50002 |
| | Tahoe (5 pin taillight plug) | 2007-13 | 40920, 40930, 40940, 40950 40955, 40965, 40975 | 0.5 | 7 Blade | | 47685 | 56103 | 50002 |
| | Tahoe (5 pin taillight plug) | 2007-13 | 41155 | 0.5 | 4 Flat | | 47685 | 56103 | 50002 |
| | Tahoe (6 pin taillight plug) | 2007-13 | 40920, 40930, 40940, 40950 40955, 40965, 40975 | 0.5 | 7 Blade | | 47685 | 56104 | 50002 |
| | Tahoe (6 pin taillight plug) | 2007-13 | 41155 | 0.5 | 4 Flat | | 47685 | 56104 | 50002 |
| | Tahoe (4 pin taillight plug) | 2014 | 40920, 40930, 40940, 40950 40955, 40965, 40975 | 0.5 | 7 Blade | | | 56102 | 50002 |
| | Tahoe (4 pin taillight plug) | 2014 | 41155 | 0.5 | 4 Flat | | | 56102 | 50002 |
| | Tahoe (5 pin taillight plug) | 2014 | 40920, 40930, 40940, 40950 40955, 40965, 40975 | 0.5 | 7 Blade | | | 56103 | 50002 |
| | Tahoe (5 pin taillight plug) | 2014 | 41155 | 0.5 | 4 Flat | | | 56103 | 50002 |

| Make | Model | Year | Plug-In Simple! [®] Vehicle Specific Wiring Kit | Est. Install Time Hours | Universal | 5th Wheel Kits | Brake Control Connectors | Towed Vehicle Kits | Plug-In Simple! [®] Camera |
|---------------------------------|--------------------------------|----------|--|----------------------------------|-----------------|----------------------|--------------------------------|--------------------------|---|
| CHEVROLET | Tahoe (6 pin taillight plug) | 2014 | 40920, 40930, 40940, 40950 40955, 40965, 40975 | 0.5 | 7 Blade | | | 56104 | 50002 |
| | Tahoe (6 pin taillight plug) | 2014 | 41155 | 0.5 | 4 Flat | | | 56104 | 50002 |
| | Tahoe (4 pin taillight plug) | 2015 | 40920, 40930, 40940, 40950 40955, 40965, 40975 | 0.5 | 7 Blade | | | | 50002 |
| | Tahoe (4 pin taillight plug) | 2015 | 41155 | 0.5 | 4 Flat | | | | 50002 |
| | Tahoe (5 pin taillight plug) | 2015 | 40920, 40930, 40940, 40950 40955, 40965, 40975 | 0.5 | 7 Blade | | | | 50002 |
| | Tahoe (5 pin taillight plug) | 2015 | 41155 | 0.5 | 4 Flat | | | | 50002 |
| | Tahoe (6 pin taillight plug) | 2015 | 40920, 40930, 40940, 40950 40955, 40965, 40975 | 0.5 | 7 Blade | | | | 50002 |
| | Tahoe (6 pin taillight plug) | 2015 | 41155 | 0.5 | 4 Flat | | | | 50002 |
| | Tracker | 1998-04 | 41245 | 0.5 | Converter | | | | |
| | Trailblazer | 2002-09 | 40920, 40930, 40940, 40950 40955, 40965, 40975 | 0.5 | 7 Blade | | | | |
| | Trailblazer | 2002-09 | 41155 | 0.5 | 4 Flat | | | | |
| | Traverse | 2009-12 | 41615 | 1.5 | Power Converter | | 47875 | 56106 | |
| | Traverse (with tow package) | 2010-12 | 40940, 40950, 40955, 40965, 40975 | 0.5 | 7 Blade | | 47875 | 56106 | |
| | Traverse (with tow package) | 2010-12 | 41155 | 0.5 | 4 Flat | | 47875 | 56106 | |
| | Traverse (without tow package) | 2013-16 | 41150 | 1.5 | Power Converter | | 47875 | | |
| | Traverse (with tow package) | 2013-16 | 40920, 40930, 40940, 40950 40955, 40965, 40975 | 0.5 | 7 Blade | | 47875 | | |
| | Traverse (with tow package) | 2013-16 | 41155 | 0.5 | 4 Flat | | 47875 | | |
| | Trax | 2015-16 | N/A | | Power Converter | | | | |
| | Uplander | 2005-08 | 41175 | 1 | 4 Flat | | | | |
| | Van (full size) | 1971-86 | N/A | | 4 Flat | | | | |
| Van (full size)(except Express) | 1987-96 | 41305 | 0.5 | 4 Flat | | | | | |
| Vega | 1974-77 | N/A | | 4 Flat | | | | | |
| Venture | 1997-05 | 41365 | 0.5 | Converter | | | | | |
| CHRYSLER | 200 | 2015-16 | N/A | | Power Converter | | | | |
| | 300 | 2005-07 | 42285 | 1 | 4 Flat | | | | |
| | 300 | 2008-09 | 42295 | 1.5 | Power Converter | | | | |
| | 300 Sedan | 2010-14 | N/A | | Power Converter | | | | |
| | 300C | 2005-09 | 42295 | 1.5 | Power Converter | | | | |
| | 300M | 1999-04 | 42275 | 1.5 | Power Converter | | | | |
| | 300 Touring | 2005-07 | N/A | | 4 Flat | | | | |
| | 300 Touring | 2008-09 | N/A | | Power Converter | | | | |
| | Aspen | 2007-09 | 42245 | 1.5 | Power Converter | | 47755 | | |
| | Aspen (with tow package) | Early 07 | 42145, 42190 | 0.5 | 7 Blade | | | | |
| | Aspen (with tow package) | 2007-09 | 40940, 40950, 40955, 40965, 40975 | 0.5 | 7 Blade | | 47755 | | |
| | Aspen (with tow package) | 2007-09 | 41155 | 0.5 | 4 Flat | | 47755 | | |
| | Cirrus | 1995-00 | N/A | | Converter | | | | |
| | Concorde | 1993-97 | N/A | | Power Converter | | | | |
| | Concorde | 1998-02 | 42275 | 1.5 | Power Converter | | | | |
| | Concorde | 2003-04 | N/A | | Power Converter | | | | |
| | Cordoba | 1980-83 | N/A | | 4 Flat | | | | |
| | Crossfire | 2004-06 | N/A | | Power Converter | | | | |
| | Imperial | 1971-83 | N/A | | 4 Flat | | | | |
| | Imperial | 1984-93 | N/A | | Power Converter | | | | |
| | Laser | 1984-87 | N/A | | Power Converter | | | | |
| | Le Baron | 1977-89 | N/A | | 4 Flat | | | | |
| | Le Baron | 1990-95 | N/A | | Power Converter | | | | |
| | LHS | 1994-01 | N/A | | Power Converter | | | | |
| | LHS | 1999 | 42275 | 1.5 | Power Converter | | | | |
| | New Yorker | 1975-87 | N/A | | 4 Flat | | | | |
| | New Yorker | 1988-95 | N/A | | Power Converter | | | | |
| | Pacifica | 2004-08 | 42415 | 1.5 | Power Converter | | | | |
| | Pacifica (with tow package) | 2003-08 | 42145, 42190 | 0.5 | 7 Blade | | | | |
| | PT Cruiser | 2001-10 | 42435 | 1.5 | Power Converter | | | | |
| | Town & Country | 1984-90 | N/A | | 4 Flat | | | | |
| | Town & Country | 1991-95 | 42205 | 1 | 4 Flat | | | | |
| | Town & Country | 1996-00 | 42215 | 1 | Converter | | | | |
| | Town & Country | 2001-03 | 42225 | 1 | Converter | | | | |
| | Town & Country | 2004-07 | 42235 | 1 | 4 Flat | | | | |
| | Town & Country | 2008-10 | 42175 | 1.5 | Power Converter | | | | |
| Town & Country | 2011-16 | 41995 | 1.5 | Power Converter | | | | | |
| Sebring | 1995-01 | N/A | | See Dealer | | | | | |
| Sebring | 2002-06 | N/A | | Power Converter | | | | | |
| Sebring | 2007-10 | 42265 | 1.5 | Power Converter | | | | | |



| Make | Model | Year | Plug-In Simple! [®] Vehicle Specific Wiring Kit | Est. Install Time Hours | Universal | 5th Wheel Kits | Brake Control Connectors | Towed Vehicle Kits | Plug-In Simple! [®] Camera |
|-------------------------------|---------------------------------------|-----------------------------------|--|----------------------------------|-----------------|----------------------|--------------------------------|--------------------------|---|
| DIAHATSU | Charade | 1989-93 | N/A | | Converter | | | | |
| | Rocky | 1990-94 | N/A | | Converter | | | | |
| DODGE | 400 | 1982-83 | N/A | | 4 Flat | | | | |
| | 600 | 1983-88 | N/A | | 4 Flat | | | | |
| | Aries | 1981-89 | N/A | | 4 Flat | | | | |
| | Arrow Pickup | 1979-83 | N/A | | Converter | | | | |
| | Aspen | 1976-80 | N/A | | 4 Flat | | | | |
| | Avenger | 1995-00 | N/A | | 4 Flat | | | | |
| | Avenger | 2008-10 | 42255 | 1.5 | Power Converter | | | | |
| | Avenger | 2011-14 | 42274 | 1.5 | Power Converter | | | | |
| | Caliber | 2007 | 42125 | 1.5 | Power Converter | | | | |
| | Caliber | 2008-12 | 42175 | 1.5 | Power Converter | | | | |
| | Caravan / Grand Caravan | 1984-90 | N/A | | 4 Flat | | | | |
| | Caravan / Grand Caravan | 1991-95 | 42205 | 1 | 4 Flat | | | | |
| | Caravan / Grand Caravan | 1996-00 | 42215 | 1 | Converter | | | | |
| | Caravan / Grand Caravan | 2001-03 | 42225 | 1 | Converter | | | | |
| | Caravan / Grand Caravan | 2004-07 | 42235 | 1 | 4 Flat | | | | |
| | Caravan / Grand Caravan | 2008-10 | 42175 | 1.5 | Power Converter | | | | |
| | Caravan / Grand Caravan | 2011-16 | 41995 | 1.5 | Power Converter | | | | |
| | Challenger | 1976-80 | N/A | | 4 Flat | | | | |
| | Challenger | 1981-83 | N/A | | Converter | | | | |
| | Challenger | 2008-14 | 42285 | 1 | 4 Flat | | | | |
| | Challenger | 2015-16 | N/A | | Power Converter | | | | |
| | Charger | 1975-87 | N/A | | 4 Flat | | | | |
| | Charger | 2006-10 | 42285 | 1 | 4 Flat | | | | |
| | Charger | 2011-14 | 42165 | 1.5 | Power Converter | | | | |
| | Charger | 2015-16 | N/A | | Power Converter | | | | |
| | Colt | 1975-95 | N/A | | Converter | | | | |
| | Dakota | 1987-94 | 42105 | 0.5 | 4 Flat | | | | |
| | Dakota | 1995-96 | 42115 | 0.5 | 4 Flat | | | | |
| | Dakota | 1997-03 | 42115 | 0.5 | 4 Flat | | 47755 | | |
| | Dakota | 2004-11 | 42205 | 0.5 | 4 Flat | | 47755 | | |
| | Dakota (with tow package) | 2000-10 | 42145, 42190 | 0.5 | 7 Blade | | 47755 | | |
| | Dart | 2013-16 | 42104 | 1.5 | Power Converter | | | | |
| | Daytona | 1984-91 | N/A | | 4 Flat | | | | |
| | Daytona | 1992-93 | N/A | | Converter | | | | |
| | Diplomat | 1977-89 | N/A | | 4 Flat | | | | |
| | Durango | 1998-03 | 42215 | 1 | Converter | | 47755 | | |
| | Durango | 2004-09 | 42245 | 1 | Converter | | 47755 | | |
| | Durango (with tow package) (early 07) | 2000-07 | 42145, 42190 | 0.5 | 7 Blade | | 47755 | | |
| | Durango (with tow package) | 2007-09 | 40940, 40950, 40955, 40965, 40975 | 0.5 | 7 Blade | | 47755 | | |
| | Durango (with tow package) | 2007-09 | 41155 | 0.5 | 4 Flat | | 47755 | | |
| | Durango (with tow package) | 2010 | 40940, 40950, 40955, 40965, 40975 | 0.5 | 7 Blade | | | | |
| | Durango (with tow package) | 2010 | 41155 | 0.5 | 4 Flat | | | | |
| | Durango (with tow package) | 2011-12 | 40940, 40950, 40955, 40965, 40975 | 0.5 | 7 Blade | | 53035 | | |
| Durango (with tow package) | 2011-12 | 41155 | 0.5 | 4 Flat | | 53035 | | | |
| Durango (without tow package) | 2011-13 | 42175 | 1.5 | Power Converter | | | | | |
| Durango (with tow package) | 2013-15 | 40940, 40950, 40955, 40965, 40975 | 0.5 | 7 Blade | | | | | |
| Durango (with tow package) | 2013-15 | 41155 | 0.5 | 4 Flat | | | | | |
| Durango (without tow package) | 2014-15 | 42214 | 1.5 | Power Converter | | | | | |
| Dynasty | 1988-93 | N/A | | 4 Flat | | | | | |
| Intrepid | 1998-04 | 42275 | 1.5 | Power Converter | | | | | |
| Journey | 2009 | 42155 | 1.5 | Power Converter | | | | | |
| Journey (with tow package) | 2009-10 | 40940, 40950, 40955, 40965, 40975 | 0.5 | 7 Blade | | | | | |
| Journey (with tow package) | 2009-10 | 41155 | 0.5 | 4 Flat | | | | | |
| Journey | 2010 | N/A | | 4 Flat | | | | | |
| Journey | 2011-15 | N/A | | Power Converter | | | | | |
| Lancer | 1985-89 | N/A | | 4 Flat | | | | | |
| Magnum | 2005-08 | 42195 | 1.5 | Power Converter | | | | | |
| Mirada | 1980-83 | N/A | | 4 Flat | | | | | |
| Neon | 1995-06 | N/A | | 4 Flat | | | | | |

| Make | Model | Year | Plug-In Simple! [®] Vehicle Specific Wiring Kit | Est. Install Time Hours | Universal | 5th Wheel Kits | Brake Control Connectors | Towed Vehicle Kits | Plug-In Simple! [®] Camera |
|-----------------------------|---|--------------|--|----------------------------------|-----------------|----------------------|--------------------------------|--------------------------|---|
| DODGE | Nitro | 2007-12 | 42485 | 1.5 | Power Converter | | | | |
| | Nitro (with tow package) | 2007-09 | 40940, 40950, 40955, 40965, 40975 | 0.5 | 7 Blade | | | | |
| | Nitro (with tow package) | 2007-09 | 41155 | 0.5 | 4 Flat | | | | |
| | Omni | 1978-90 | N/A | | 4 Flat | | | | |
| | Raider | 1987-89 | N/A | | Converter | | | | |
| | Ram Pickup (all sizes) | 1976-86 | N/A | | 4 Flat | | | | |
| | Ram Pickup (all sizes) | 1987-94 | 42105 | 0.5 | 4 Flat | | | | |
| | Ram Pickup (all sizes) | 1995-01 | 42115 | 0.5 | 4 Flat | | 47755 | | |
| | Ram Pickup (cab & chassis only) | 1995-02 | 42105 | 0.5 | 4 Flat | | 47755 | | |
| | Ram Pickup 1500 | 2002-06 | 42135 | 0.5 | Converter | | 47755 | | |
| | Ram Pickup 1500 | 2007-09 | 42205 | 0.5 | 4 Flat | | 47755 | | |
| | Ram 1500 (with tow package) | 2000-09 | 42145, 42190 | 0.5 | 7 Blade | 42137 | 47755 | | |
| | Ram 1500 (with tow package) | 2010-12 | 40940, 40950, 40955, 40965, 40974, 40975 | 0.5 | 7 Blade | 41157 | 53015 | | 50002 |
| | Ram 1500 (with tow package) | 2010-12 | 41155 | 0.5 | 4 Flat | 41157 | 53015 | | 50002 |
| | Ram 1500 (with tow package) | 2013-14 | 40940, 40950, 40955, 40965, 40974, 40975 | 0.5 | 7 Blade | 41157 | 53055 | | 50002 |
| | Ram 1500 (with tow package) | 2013-14 | 41155 | 0.5 | 4 Flat | 41157 | 53055 | | 50002 |
| | Ram 1500 (with tow package) | 2015-16 | 40940, 40950, 40955, 40965, 40974, 40975 | 0.5 | 7 Blade | 41157 | 53056 | | 50002 |
| | Ram 1500 (with tow package) | 2015-16 | 41155 | 0.5 | 4 Flat | 41157 | 53056 | | 50002 |
| | Ram Pickup 2500/3500 | 2002 | 42115 | 0.5 | 4 Flat | | 47755 | | |
| | Ram Pickup 2500/3500 | 2003-06 | 42135 | 0.5 | Converter | | 47755 | | |
| | Ram Pickup 2500/3500 | 2007-09 | 42205 | 0.5 | 4 Flat | | 47755 | | |
| | Ram Pickup 2500/3500 (with tow package) | 2000-09 | 42145, 42190 | 0.5 | 7 Blade | 42137 | 47755 | | |
| | Ram Pickup 2500/3500 (with tow package) | 2010-12 | 40940, 40950, 40955, 40965, 40974, 40975 | 0.5 | 7 Blade | 41157 | 53015 | | 50002 |
| | Ram Pickup 2500/3500 (with tow package) | 2010-12 | 41155 | 0.5 | 4 Flat | 41157 | 53015 | | 50002 |
| | Ram Pickup 2500/3500 (with tow package) | 2013-14 | 40940, 40950, 40955, 40965, 40974, 40975 | 0.5 | 7 Blade | 41157 | 53055 | | 50002 |
| | Ram Pickup 2500/3500 (with tow package) | 2013-14 | 41155 | 0.5 | 4 Flat | 41157 | 53055 | | 50002 |
| | Ram Pickup 2500/3500 (with tow package) | 2015-16 | 40940, 40950, 40955, 40965, 40974, 40975 | 0.5 | 7 Blade | 41157 | 53056 | | 50002 |
| | Ram Pickup 2500/3500 (with tow package) | 2015-16 | 41155 | 0.5 | 4 Flat | 41157 | 53056 | | 50002 |
| | Ram 50/50 Series Pickup | 1979-93 | N/A | | Converter | | | | |
| | Ram Promaster | 2014-16 | 42304 | 1.5 | Power Converter | | | | |
| | Ram Promaster (with tow package) | 2014-16 | 40940, 40950, 40955, 40965, 40975 | 0.5 | 7 Blade | | | | |
| | Ram Promaster (with tow package) | 2014-16 | 41155 | 0.5 | 4 Flat | | | | |
| | Ram Tradesman Van (with tow package) | 2014-15 | N/A | | 7 Blade | | | | |
| | Ram Van | 1971-92 | N/A | | 4 Flat | | | | |
| | Ram Van | 1993-98 | 42305 | 0.5 | 4 Flat | | | | |
| | Ram Van | 1999-00 | 42315 | 0.5 | 4 Flat | | | | |
| | Ram Van | 2001-03 | 42145, 42190 | 0.5 | 7 Blade | | | | |
| | Ramcharger / Trailduster | 1974-87 | N/A | | 4 Flat | | | | |
| | Ramcharger / Trailduster | 1988-93 | 42105 | 0.5 | 4 Flat | | | | |
| | Rampage | 1982-84 | N/A | | 4 Flat | | | | |
| | Scamp | 1983 | N/A | | 4 Flat | | | | |
| Shadow | 1987-94 | N/A | | 4 Flat | | | | | |
| Spirit | 1989-95 | N/A | | Power Converter | | | | | |
| Sprinter | 2002-08 | N/A | | Converter | | | | | |
| Sprinter (with tow package) | 2004-08 | 42145, 42190 | 0.5 | 7 Blade | | | | | |
| Sprinter 2500 | 2009 | 42145, 42190 | 0.5 | 7 Blade | | | | | |
| Sprinter 3500 | 2009 | 42145, 42190 | 0.5 | 7 Blade | | | | | |
| Stealth | 1991-96 | N/A | | Power Converter | | | | | |
| Stratus | 1995-07 | N/A | | Converter | | | | | |
| Vista | 1984-91 | N/A | | Converter | | | | | |
| EAGLE | Eagle | 1980-88 | N/A | | Converter | | | | |
| | Pacer | 1978-80 | N/A | | 4 Flat | | | | |
| | Spirit | 1979-83 | N/A | | 4 Flat | | | | |
| | Summit | 1989-96 | N/A | | Converter | | | | |
| | Talon | 1990-91 | N/A | | 4 Flat | | | | |
| | Talon | 1992-97 | N/A | | Power Converter | | | | |
| | Vision | 1993-97 | N/A | | Power Converter | | | | |



| Make | Model | Year | Plug-In Simple! [®] Vehicle Specific Wiring Kit | Est. Install Time Hours | Universal | 5th Wheel Kits | Brake Control Connectors | Towed Vehicle Kits | Plug-In Simple! [®] Camera |
|-----------------------------------|---|-----------------------------------|--|----------------------------------|-----------------|----------------------|--------------------------------|--------------------------|---|
| FIAT | 500 | 2012-15 | 40274 | 1.5 | Power Converter | | | | |
| | 500L | 2014-15 | 41204 | 1.5 | Power Converter | | | | |
| FORD | Aerostar | 1986-96 | N/A | | Converter | | | | |
| | Aerostar | 1997 | 40655 | 1 | 4 Flat | | | | |
| | Aspire | 1994-97 | N/A | | Converter | | | | |
| | Bronco | 1980-86 | 40115 | 0.5 | 4 Flat | | | | |
| | Bronco | 1987-88 | 40415 | 0.5 | 4 Flat | | | | |
| | Bronco | 1989-91 | 40425 | 0.5 | 4 Flat | | | | |
| | Bronco | 1992-93 | 40435 | 0.5 | 4 Flat | | 47695 | | |
| | Bronco | 1994-96 | 40435 | 0.5 | 4 Flat | | 47715 | | |
| | Bronco II | 1984-86 | N/A | | 4 Flat | | | | |
| | Bronco II | 1987-91 | 40405 | 0.5 | 4 Flat | | | | |
| | Contour | 1995-00 | N/A | | 4 Flat | | | | |
| | C-Max | 2013 | N/A | | Power Converter | | | | |
| | Crown Victoria / LTD | 1975-91 | N/A | | 4 Flat | | | | |
| | Crown Victoria / LTD | 1992-97 | 40505 | 1 | 4 Flat | | | | |
| | Crown Victoria / LTD / No police interceptor | 1998-03 | 40504 | 1.5 | Power Converter | | | | |
| | Crown Victoria / LTD | 2004-09 | N/A | | Power Converter | | | | |
| | E-350 RV, E-450 RV | 2009-11 | N/A | | 7 Blade | | 47855 | | |
| | Econoline Van | 1975-91 | N/A | | 4 Flat | | | | |
| | Econoline Van | 1992-93 | 40315 | 1.5 | Power Converter | | | | |
| | Econoline Van | 1994 | 40315 | 1.5 | Power Converter | | 47715 | | |
| | Econoline Van | 1995-01 | 40655 | 0.5 | 4 Flat | | 47715 | | |
| | Econoline Van | 2002-03 | 40655 | 0.5 | 4 Flat | | | | |
| | Econoline Van | 2004-08 | N/A | | 4 Flat | | 47715 | | |
| | Econoline Van (with factory 7 blade) | 2004-08 | 40940, 40950, 40955, 40965, 40975 | 0.5 | 7 Blade | | 47715 | | |
| | Econoline Van (with factory 7 blade) | 2004-08 | 41155 | 0.5 | 4 Flat | | 47715 | | |
| | Econoline Van (with factory 4 flat) | 2009-13 | 40665 | 0.5 | 4 Flat | | 47855 | | |
| | Econoline Van (with factory 7 blade) | 2009-15 | 40940, 40950, 40955, 40965, 40975 | 0.5 | 7 Blade | | 47855 | | |
| | Econoline Van (with factory 7 blade) | 2009-15 | 41155 | 0.5 | 4 Flat | | 47855 | | |
| | Econoline E-Series Van (without tow package) | 2004-15 | 40495 | 1.5 | Power Converter | | | | |
| | Econoline Wagon, E-350 | 2004-10 | N/A | | 4 Flat | | | | |
| | Edge | 2007-10 | 40495 | 1.5 | Power Converter | | | 56000 | |
| | Edge | 2011-13 | 40695 | 1.5 | Power Converter | | | 56001 | |
| | Escape (early 2004) | 2001-04 | 40315 | 1.5 | Power Converter | | | | |
| | Escape (with tow package) | 2001-04 | 40445 | 1 | 4 Flat | | | | |
| | Escape | 2005-07 | 40465 | 1.5 | Power Converter | | | | |
| | Escape (with tow package) | 2005-07 | 40455 | 1 | 4 Flat | | | | |
| | Escape | 2008-12 | 40495 | 1.5 | Power Converter | | | 56000 | |
| | Escape | 2013-16 | 40514 | 1.5 | Power Converter | | | | |
| | Escape (with tow package) | 2013-16 | 40940, 40950, 40955, 40965, 40975 | 0.5 | 7 Blade | | | | |
| | Escape (with tow package) | 2013-16 | 41155 | 0.5 | 4 Flat | | | | |
| | Escort Sedan | 1981-96 | N/A | | Power Converter | | | | |
| | Escort Sedan | 1997-01 | 40655 | 1 | 4 Flat | | | | |
| | Escort Wagon | 1997-99 | N/A | | Converter | | | | |
| | Excursion (without tow package) | 2000-03 | 40655 | 0.5 | 4 Flat | | 47715 | | |
| | Excursion | 2000-05 | 40940, 40950, 40955, 40965, 40975 | 0.5 | 7 Blade | | 47715 | | 50002 |
| | Excursion | 2000-05 | 41155 | 0.5 | 4 Flat | | 47715 | | 50002 |
| | EXP | 1982-88 | N/A | | Power Converter | | | | |
| | Expedition (without tow package) | 1997-03 | 40655 | 0.5 | 4 Flat | | 47715 | | |
| | Expedition | 1997-03 | 40135 | 0.5 | 4 Flat | | 47715 | | |
| | Expedition (with factory 4 flat) | 2000-02 | 40925 | 0.5 | 4 Flat | | 47715 | | |
| Expedition (with factory 7 blade) | 1999-12 | 40940, 40950, 40955, 40965, 40975 | 0.5 | 7 Blade | | 47715 | | | |
| Expedition (with factory 7 blade) | 1999-12 | 41155 | 0.5 | 4 Flat | | 47715 | | | |
| Expedition (with factory 7 blade) | 2013-15 | 40940, 40950, 40955, 40965, 40975 | 0.5 | 7 Blade | | 47855 | | | |
| Expedition (with factory 7 blade) | 2013-15 | 41155 | 0.5 | 4 Flat | | 47855 | | | |
| Explorer | 1991-94 | 40305 | 0.5 | 4 Flat | | | | | |
| Explorer (with tow package) | 1991-94 | 40905 | 0.5 | 4 Flat | | | | | |
| Explorer | 1996-97 | 40325 | 0.5 | 4 Flat | | | | | |
| Explorer (with tow package) | 1995-99 | 40915 | 0.5 | 4 Flat | | | | | |

| Make | Model | Year | Plug-In Simple! [®] Vehicle Specific Wiring Kit | Est. Install Time Hours | Universal | 5th Wheel Kits | Brake Control Connectors | Towed Vehicle Kits | Plug-In Simple! [®] Camera |
|-------------------------|--|-----------------------------------|--|----------------------------------|-----------------|----------------------|--------------------------------|--------------------------|---|
| FORD | Explorer | 1995-00 | 40315 | 1.5 | Power Converter | | | | |
| | Explorer | 2001 | N/A | | 4 Flat | | 47715 | | |
| | Explorer (with tow package) | 2000-01 | 40915 | 0.5 | 4 Flat | | 47715 | | |
| | Explorer (2 door sport) (without tow package) | 2001-03 | 40655 | 0.5 | 4 Flat | | 47715 | | |
| | Explorer (4 door) (without tow package) | 2002-03 | 40655 | 0.5 | 4 Flat | | 47715 | | |
| | Explorer (with factory 4 flat) | 2002-05 | 40335 | 0.5 | 4 Flat | | 47715 | | |
| | Explorer | 2006-10 | 40345 | 0.5 | 4 Flat | | 47715 | | |
| | Explorer | 2011-16 | 40285 | 1.5 | Power Converter | | 47715 | | |
| | Explorer (with factory 7 blade) | 2002-13 | 40940, 40950, 40955, 40965, 40975 | 0.5 | 7 Blade | | 47715 | | |
| | Explorer (with factory 7 blade) | 2002-13 | 41155 | 0.5 | 4 Flat | | 47715 | | |
| | Explorer (with factory 7 blade) | 2014-16 | 40940, 40950, 40955, 40965, 40975 | 0.5 | 7 Blade | | 47715 | | |
| | Explorer (with factory 7 blade) | 2014-16 | 41155 | 0.5 | 4 Flat | | 47715 | | |
| | Explorer Sport Trac | 2001-07 | N/A | | 4 Flat | | | | |
| | Explorer Sport Trac (without tow package) | 2002-03 | 40655 | 0.5 | 4 Flat | | 47715 | | |
| | Explorer Sport Trac | 2008-09 | N/A | | Power Converter | | | | |
| | Explorer Sport Trac (with tow package) | 2007-10 | 40940, 40950, 40955, 40965, 40975 | 0.5 | 7 Blade | | | | |
| | Explorer Sport Trac (with tow package) | 2007-10 | 41155 | 0.5 | 4 Flat | | | | |
| | F-Series Pickup | 1973-79 | 40105 | 0.5 | 4 Flat | | | | |
| | F-150, 250, 350 | 1980-86 | 40115 | 0.5 | 4 Flat | | | | |
| | F-150, 250, 350 | 1987-91 | 40125 | 0.5 | 4 Flat | | | | |
| | F-150, 250, 350 | 1992-93 | 40125 | 0.5 | 4 Flat | | 47695 | | |
| | F-150, 250, 350 | 1994-96 | 40125 | 0.5 | 4 Flat | | 47715 | | |
| | F-150 (mfg. 1/96 - 10/96) | 1997 | 40135 | 0.5 | 4 Flat | | 47715 | | |
| | F-150 (mfg. 11/96) | 1997-99 | 40145 | 0.5 | 4 Flat | 40147 | 47715 | | |
| | F-150 | 2000-03 | 40145 | 0.5 | 4 Flat | 40147 | 47715 | 56005 | |
| | F-150 (Regular cab only) | 2004 | 40145 | 0.5 | 4 Flat | 40147 | 47715 | 56005 | |
| | F-150 (new body style) | 2004 | 40175 | 0.5 | 4 Flat | 40177 | 47715 | 56005 | |
| | F-150 | 2005-08 | 40185 | 0.5 | 4 Flat | | 47715 | 56005 | |
| | F-150 (with tow package) | 2008 | 40940, 40950, 40955, 40965, 40975 | 0.5 | 7 Blade | 41157 | 47715 | 56005 | 50002 |
| | F-150 (with tow package) | 2008 | 41155 | 0.5 | 4 Flat | 41157 | 47715 | 56005 | 50002 |
| | F-150 | 2009-14 | 40735 | 0.5 | 4 Flat | | 47845 | 56000 | |
| | F-150 | 2015 | 40735 | 0.5 | 4 Flat | | | | |
| | F-150 (with tow package) | 2009-14 | 40940, 40950, 40955, 40965, 40975 | 0.5 | 7 Blade | 41157 | 47845 | 56000 | 50002 |
| | F-150 (with tow package) | 2009-14 | 41155 | 0.5 | 4 Flat | 41157 | 47845 | 56000 | 50002 |
| | F-150 (with tow package) | 2015 | 40940, 40950, 40955, 40965, 40974, 40975 | 0.5 | 7 Blade | 41157 | | | 50002 |
| | F-150 (with tow package) | 2015 | 41155 | 0.5 | 4 Flat | 41157 | | | 50002 |
| | F-250 Light Duty (mfg. 1/96 - 10/96) | 1997 | 40135 | 0.5 | 4 Flat | | 47715 | | |
| | F-250 Light Duty (mfg. 11/96 - 2001) | 1997-01 | 40145 | 0.5 | 4 Flat | 40147 | 47715 | | |
| | F-250 Heavy Duty, F-350 | 1987-93 | 40125 | 0.5 | 4 Flat | | | | |
| | F-250 Heavy Duty, F-350 | 1994-97 | 40125 | 0.5 | 4 Flat | | 47715 | | |
| | F-250 Heavy Duty, F-350 | 1999-01 | 40155 | 0.5 | 4 Flat | 40157 | 47715 | | |
| | F-250 Heavy Duty, F-350 | 2002-04 | 40165 | 0.5 | 4 Flat | 40167 | 47715 | | |
| | F-250 Heavy Duty, F-350 | 2005-07 | 40195 | 0.5 | 4 Flat | | 47735 | | |
| | F-250, 350 All | 2008-16 | 40755 | 0.5 | 4 Flat | | 47855 | | |
| | F-250, 350 (with tow package) | 2008-16 | 40940, 40950, 40955, 40965, 40974, 40975 | 0.5 | 7 Blade | 41157 | 47855 | | 50002 |
| | F-250, 350 (with tow package) | 2008-16 | 41155 | 0.5 | 4 Flat | 41157 | 47855 | | 50002 |
| | F-450 Heavy Duty, F-550 | 2005-07 | N/A | | 7 Blade | | 47735 | | |
| | F-450 Heavy Duty, F-550 | 2008-15 | N/A | | 7 Blade | | 47855 | | |
| | F-53 Motor Home Chasis | 2000-14 | N/A | | 7 Blade | | 47715 | | |
| | Fairmont | 1978-83 | N/A | | 4 Flat | | | | |
| Festiva | 1988-93 | N/A | | Converter | | | | | |
| Fiesta (5 door) | 2011-15 | 40375 | 1.5 | Power Converter | | | | | |
| Fiesta Sedan | 2011-13 | 40485 | 1 | Converter | | | | | |
| Fiesta Sedan | 2014-15 | 40464 | 1.5 | Power Converter | | | | | |
| Five Hundred | 2005-07 | 40475 | 1 | 4 Flat | | | | | |
| Flex | 2006-08 | N/A | | | | 47715 | | | |
| Flex | 2009-11 | 40275 | 1 | 4 Flat | | 47715 | | | |
| Flex (with tow package) | 2009-11 | 40940, 40950, 40955, 40965, 40975 | 0.5 | 7 Blade | | 47715 | | 50002 | |
| Flex (with tow package) | 2009-11 | 41155 | 0.5 | 4 Flat | | 47715 | | 50002 | |
| Flex | 2012-14 | 40275 | 1 | 4 Flat | | 47845 | | | |
| Flex (with tow package) | 2012-14 | 40940, 40950, 40955, 40965, 40975 | 0.5 | 7 Blade | | 47845 | | 50002 | |



| Make | Model | Year | Plug-In Simple! [®] Vehicle Specific Wiring Kit | Est. Install Time Hours | Universal | 5th Wheel Kits | Brake Control Connectors | Towed Vehicle Kits | Plug-In Simple! [®] Camera |
|--|---------------------------------------|-----------------------------------|--|----------------------------------|-----------------------------|----------------------|--------------------------------|--------------------------|---|
| FORD | Flex (with tow package) | 2012-14 | 41155 | 0.5 | 4 Flat | | 47845 | | 50002 |
| | Flex | 2015 | 40275 | 1 | 4 Flat | | | | |
| | Flex (with tow package) | 2015 | 40940, 40950, 40955, 40965, 40975 | 0.5 | 7 Blade | | | | |
| | Flex (with tow package) | 2015 | 41155 | 0.5 | 4 Flat | | | | |
| | Focus Wagon (built before 11/2002) | 2000-03 | 40655 | 1 | 4 Flat | | | | |
| | Focus (except Sedan) | 2004-07 | 40495 | 1.5 | 4 Flat | | | | |
| | Focus Sedan | 2000-06 | N/A | | Power Converter | | | | |
| | Focus Sedan & Coupe | 2008-11 | 40495 | 1.5 | Power Converter | | | | |
| | Focus Sedan | 2012-16 | 40545 | 1.5 | Power Converter | | | 56007 | |
| | Focus Hatchback | 2012-16 | 40554 | 1.5 | Power Converter | | | 56008 | |
| | Focus ST | 2013-16 | N/A | | Power Converter | | | | |
| | Freestar | 2005-07 | N/A | | Power Converter | | | | |
| | Freestyle | 2005-07 | 40475 | 1 | 4 Flat | | | | |
| | Fusion | 2006-12 | 40685 | 1.5 | Power Converter | | | | |
| | Fusion | 2013-16 | 40444 | 1.5 | Power Converter | | | | |
| | Futura | 1978-83 | N/A | | 4 Flat | | | | |
| | Granada | 1975-82 | N/A | | Converter | | | | |
| | LTD II | 1977-79 | N/A | | 4 Flat | | | | |
| | Mustang (all) | 1965-86 | N/A | | 4 Flat | | | | |
| | Mustang (GT only) | 1987-93 | N/A | | Power Converter | | | | |
| | Mustang (except GT) | 1987-93 | N/A | | 4 Flat | | | | |
| | Mustang (except Cobra) | 1994-04 | 40505 | 1 | 4 Flat | | | | |
| | Mustang (Cobra only) | 1999-00 | N/A | | Converter | | | | |
| | Mustang or Cobra | 2005-09 | N/A | | 4 Flat | | | | |
| | Mustang | 2010-16 | 40525 | 1.5 | Power Converter | | | | |
| | Pinto | 1975-80 | N/A | | 4 Flat | | | | |
| | Probe | 1988-97 | N/A | | Power Converter | | | | |
| | Ranger | 1985 | N/A | | 4 Flat | | | | |
| | Ranger | 1986-92 | 40205 | 0.5 | 4 Flat | | | | |
| | Ranger | 1993-97 | 40215 | 0.5 | Converter | | | | |
| | Ranger | 1998-99 | 40215 | 0.5 | Converter | | | 56003 | |
| | Ranger Pickup (without STX) | 2000-10 | 40655 | 0.5 | 4 Flat | | | 56004 | |
| | Ranger Pickup | 2011 | 40495 | 1.5 | 4 Flat | | | 56000 | |
| | Ranger (with tow package) | 1998-99 | 40915 | 0.5 | 4 Flat | | | 56003 | |
| | Ranger (with tow package) | 2000-09 | N/A | | 4 Flat | | | 56004 | |
| | Ranger STX | 2005-11 | N/A | | Converter | | | 56000 | |
| | Taurus | 1986 | N/A | | Converter | | | | |
| | Taurus | 1987-91 | N/A | | 4 Flat | | | | |
| | Taurus Sedan | 1992-95 | 40555 | 1 | 4 Flat | | | | |
| | Taurus Sedan | 1996-99 | 40565 | 1 | Converter | | | | |
| | Taurus Sedan | 2000-03 | 40575 | 1 | 4 Flat | | | | |
| | Taurus Sedan | 2004-06 | N/A | | 4 Flat | | | | |
| | Taurus Sedan | 2008-09 | 40585 | 1 | 4 Flat | | | | |
| | Taurus Sedan | 2010-12 | 40595 | 1 | Converter | | | | |
| | Taurus Sedan | 2013-15 | N/A | | Power Converter | | | | |
| | Taurus Wagon | 1986-95 | N/A | | 4 Flat | | | | |
| | Taurus Wagon | 1996-01 | N/A | | Converter | | | | |
| | Taurus X | 2008-09 | 40535 | 1 | 4 Flat | | | | |
| | Tempo | 1984-94 | N/A | | Power Converter | | | | |
| | Thunderbird | 1974-82 | N/A | | 4 Flat | | | | |
| | Thunderbird | 1983-97 | N/A | | Power Converter | | | | |
| | Thunderbird | 2002-06 | N/A | | Negative Power Converter | | | | |
| Torino | 1974-76 | N/A | | 4 Flat | | | | | |
| Transit T-150 Van (without tow package) | 2015-16 | N/A | | Power Converter | | | | | |
| Transit T-150 Van (with tow package) | 2015-16 | 40940, 40950, 40955, 40965, 40975 | 0.5 | 7 Blade | | | | | |
| Transit T-150 Van (with tow package) | 2015-16 | 41155 | 0.5 | 4 Flat | | | | | |
| Transit T-250 Wagon (without tow package) | 2015-16 | N/A | | Power Converter | | | | | |
| Transit T-250 Wagon (with tow package) | 2015-16 | 40940, 40950, 40955, 40965, 40975 | 0.5 | 7 Blade | | | | | |
| Transit T-250 Wagon (with tow package) | 2015-16 | 41155 | 0.5 | 4 Flat | | | | | |
| Transit T-350 Wagon XLT (without tow package) | 2015-16 | N/A | | Power Converter | | | | | |

| Make | Model | Year | Plug-In Simple! [®] Vehicle Specific Wiring Kit | Est. Install Time Hours | Universal | 5th Wheel Kits | Brake Control Connectors | Towed Vehicle Kits | Plug-In Simple! [®] Camera |
|-----------------------------------|---|---------|--|----------------------------------|-----------------------------|----------------------|--------------------------------|--------------------------|---|
| FORD | Transit T-350 Wagon XLT (with tow package) | 2015-16 | 40940, 40950, 40955, 40965, 40975 | 0.5 | 7 Blade | | | | |
| | Transit T-350 Wagon XLT (with tow package) | 2015-16 | 41155 | 0.5 | 4 Flat | | | | |
| | Transit Connect | 2010-13 | N/A | | See Dealer | | | | |
| | Transit Connect | 2014-15 | 40264 | 1.5 | Power Converter | | | | |
| | Windstar | 1995 | 40605 | 1 | Converter | | 47715 | | |
| | Windstar | 1996-98 | 40605 | 1 | Converter | | 47715 | | |
| | Windstar (mfg. 1999-12/02) | 1999-02 | 40615 | 1.5 | Negative Power Converter | | 47715 | | |
| | Windstar (mfg. 01/03 & up) | 2003 | N/A | | Negative Power Converter | | 47715 | | |
| ZX2 | 1998-03 | 40655 | 1 | 4 Flat | | | | | |
| GEO | Metro | 1989-97 | N/A | | Power Converter | | | | |
| | Prizm | 1990-97 | N/A | | Converter | | | | |
| | Spectrum | 1987-89 | N/A | | Power Converter | | | | |
| | Storm | 1990-93 | N/A | | Power Converter | | | | |
| | Tracker | 1989-95 | N/A | | Converter | | | | |
| | Tracker | 1996-05 | 41245 | 0.5 | Converter | | | | |
| GMC | Acadia (without tow package) | 2007 | 41645 | 1 | 4 Flat | | | | |
| | Acadia (with tow package) | 2007 | 40940, 40950, 40955, 40965, 40975 | 0.5 | 7 Blade | | | | |
| | Acadia (with tow package) | 2007 | 41155 | 0.5 | 4 Flat | | | | |
| | Acadia (without tow package) | 2008-12 | 41645 | 1 | 4 Flat | | 47875 | 56107 | |
| | Acadia (with tow package) | 2008-12 | 40940, 40950, 40955, 40965, 40975 | 0.5 | 7 Blade | | 47875 | 56107 | |
| | Acadia (with tow package) | 2008-12 | 41155 | 0.5 | 4 Flat | | 47875 | 56107 | |
| | Acadia (without tow package) | 2013-16 | 41310 | | Power Converter | | 47875 | | |
| | Acadia (with tow package) | 2013-16 | 40920, 40930, 40940, 40950, 40955, 40965, 40975 | 0.5 | 7 Blade | | 47875 | | |
| | Acadia (with tow package) | 2013-16 | 41155 | 0.5 | 4 Flat | | 47875 | | |
| | Canyon | 2004-07 | 41165 | 0.5 | Converter | | | 56109 | |
| | Canyon (without tow package) | 2008-12 | 41165 | 0.5 | Converter | | | 56109 | |
| | Canyon (with tow package) | 2008-12 | 40940, 40950, 40955, 40965, 40975 | 0.5 | 7 Blade | | | 56109 | 50002 |
| | Canyon (with tow package) | 2008-12 | 41155 | 0.5 | 4 Flat | | | 56109 | 50002 |
| | Canyon (without tow package) | 2015-16 | 41164 | 1.5 | Power Converter | | | | |
| | Canyon (with tow harness) | 2015-16 | 41144 | 1 | Converter | | | | |
| | Canyon (with tow package) | 2015-16 | 40940, 40950, 40955, 40965, 40975 | 0.5 | 7 Blade | | | | 50002 |
| | Canyon (with tow package) | 2015-16 | 41155 | 0.5 | 4 Flat | | | | 50002 |
| | Denali | 1999-00 | 41125 | 0.5 | 4 Flat | | 47795 | | |
| | Denali | 2001-06 | 40920, 40930, 40940, 40950 40955, 40965, 40975 | 0.5 | 7 Blade | | 47795 | | 50002 |
| | Denali | 2001-06 | 41155 | 0.5 | 4 Flat | | 47795 | | 50002 |
| | Denali | 2007-13 | 40920, 40930, 40940, 40950 40955, 40965, 40975 | 0.5 | 7 Blade | | 47685 | | 50002 |
| | Denali | 2007-13 | 41155 | 0.5 | 4 Flat | | 47685 | | 50002 |
| | Denali | 2014 | 40920, 40930, 40940, 40950 40955, 40965, 40975 | 0.5 | 7 Blade | | | | 50002 |
| | Denali | 2014 | 41155 | 0.5 | 4 Flat | | | | 50002 |
| | Envoy | 1999-01 | 41225 | 0.5 | 4 Flat | | | | |
| | Envoy (with tow package) | 2002-09 | 40920, 40930, 40940, 40950 40955, 40965, 40975 | 0.5 | 7 Blade | | | | |
| | Envoy (with tow package) | 2002-09 | 41155 | 0.5 | 4 Flat | | | | |
| | Jimmy (full size) | 1973-84 | 41105 | 0.5 | 4 Flat | | | | |
| | Jimmy (full size) | 1985-91 | 41115 | 0.5 | 4 Flat | | | | |
| | Jimmy (full size) | 1992-94 | 41125 | 0.5 | 4 Flat | | | | |
| | Jimmy | 1995-02 | 41225 | 0.5 | 4 Flat | | | | |
| | S-15 Jimmy (2 door) | 1984-91 | 41205 | 0.5 | 4 Flat | | | | |
| | S-15 Jimmy (2 door) | 1992-94 | 41215 | 0.5 | 4 Flat | | | | |
| S-15 Jimmy (4 door) | 1991-94 | N/A | | 4 Flat | | | | | |
| Pickup (full size) | 1963-67 | N/A | | 4 Flat | | | | | |
| Pickup (full size) | 1968-84 | 41105 | 0.5 | 4 Flat | | | | | |
| Pickup (full size) | 1985-87 | 41115 | 0.5 | 4 Flat | | | | | |
| Pickup (full size) | 1988-98 | 41125 | 0.5 | 4 Flat | | | | | |
| Pickup (Classic) (old body style) | 1999-00 | 41125 | 0.5 | 4 Flat | | | | | |



GMC

| Make | Model | Year | Plug-In Simple! [®] Vehicle Specific Wiring Kit | Est. Install Time Hours | Universal | 5th Wheel Kits | Brake Control Connectors | Towed Vehicle Kits | Plug-In Simple! [®] Camera |
|------|--|---------|--|----------------------------------|-----------------|----------------------|--------------------------------|--------------------------|---|
| | Sierra 1500 (new body style) | 1999-02 | 41145 | 0.5 | 4 Flat | | 47795 | | |
| | Sierra 1500 | 2003-07 | 40920, 40930, 40940, 40950 40955, 40965, 40975 | 0.5 | 7 Blade | 41157 | 47795 | 56101 | 50002 |
| | Sierra 1500 | 2003-07 | 41155 | 0.5 | 4 Flat | 41157 | 47795 | 56101 | 50002 |
| | Sierra 1500 (new body style) | 2007-13 | 40920, 40930, 40940, 40950 40955, 40965, 40975 | 0.5 | 7 Blade | 41157 | 47685 | 56101 | 50002 |
| | Sierra 1500 (new body style) | 2007-13 | 41155 | 0.5 | 4 Flat | 41157 | 47685 | 56101 | 50002 |
| | Sierra 2500/3500 (new body style) | 1999-02 | 40920, 40930, 40940, 40950 40955, 40965, 40975 | 0.5 | 7 Blade | 41157 | 47795 | | 50002 |
| | Sierra 2500/3500 (new body style) | 1999-02 | 41155 | 0.5 | 4 Flat | 41157 | 47795 | | 50002 |
| | Sierra 2500/3500 | 2003-07 | 40920, 40930, 40940, 40950 40955, 40965, 40975 | 0.5 | 7 Blade | 41157 | 47795 | 56101 | 50002 |
| | Sierra 2500/3500 | 2003-07 | 41155 | 0.5 | 4 Flat | 41157 | 47795 | 56101 | 50002 |
| | Sierra 2500/3500 (new body style) | 2007-13 | 40920, 40930, 40940, 40950 40955, 40965, 40975 | 0.5 | 7 Blade | 41157 | 47685 | 56101 | 50002 |
| | Sierra 2500/3500 (new body style) | 2007-13 | 41155 | 0.5 | 4 Flat | 41157 | 47685 | 56101 | 50002 |
| | Sierra 1500, 2500, 3500 | 2014-16 | 40940, 40950, 40955, 40965, 40974, 40975 | 0.5 | 7 Blade | 41157 | 53075 | | 50002 |
| | Sierra 1500, 2500, 3500 | 2014-16 | 41155 | 0.5 | 4 Flat | 41157 | 53075 | | 50002 |
| | Safari | 1985-94 | N/A | | 4 Flat | | | | |
| | Safari | 1995-05 | 41225 | 0.5 | 4 Flat | | | | |
| | Sonoma / S-15 Pickup | 1985-97 | 41115 | 0.5 | 4 Flat | | | | |
| | Sonoma / S-15 Pickup | 1998-04 | 41135 | 0.5 | 4 Flat | | | | |
| | Suburban | 1973-84 | 41105 | 0.5 | 4 Flat | | | | |
| | Suburban | 1985-91 | 41115 | 0.5 | 4 Flat | | | | |
| | Suburban | 1992-99 | 41125 | 0.5 | 4 Flat | | | | |
| | Savana Van (full size) | 1996-99 | 41325 | 0.5 | Converter | | | | |
| | Savana Van (full size) | 2000-02 | 41335 | 0.5 | Converter | | | | |
| | Savana Van (full size) | 2003-15 | 41345 | 1.5 | Power Converter | | | | |
| | Savana Van (full size) (with tow package) | 2008-16 | 40940, 40950, 40955, 40965, 40975 | 0.5 | 7 Blade | | | | 50002 |
| | Savana Van (full size) (with tow package) | 2008-16 | 41155 | 0.5 | 4 Flat | | | | 50002 |
| | Terrain | 2010-16 | 41275 | 1 | 4 Flat | | | 56108 | |
| | Vandura (full size) | 1971-86 | N/A | | 4 Flat | | | | |
| | Vandura (full size) | 1987-96 | 41305 | 0.5 | 4 Flat | | | | |
| | Yukon | 1992-99 | 41125 | 0.5 | 4 Flat | | | | |
| | Yukon | 2000-06 | 40920, 40930, 40940, 40950 40955, 40965, 40975 | 0.5 | 7 Blade | | 47795 | | 50002 |
| | Yukon | 2000-06 | 41155 | 0.5 | 4 Flat | | 47795 | | 50002 |
| | Yukon (4 pin taillight plug) | 2007-14 | 40920, 40930, 40940, 40950 40955, 40965, 40975 | 0.5 | 7 Blade | | | 56102 | 50002 |
| | Yukon (4 pin taillight plug) | 2007-14 | 41155 | 0.5 | 4 Flat | | | 56102 | 50002 |
| | Yukon (5 pin taillight plug) | 2007-14 | 40920, 40930, 40940, 40950 40955, 40965, 40975 | 0.5 | 7 Blade | | | 56103 | 50002 |
| | Yukon (5 pin taillight plug) | 2007-14 | 41155 | 0.5 | 4 Flat | | | 56103 | 50002 |
| | Yukon (6 pin taillight plug) | 2007-14 | 40920, 40930, 40940, 40950 40955, 40965, 40975 | 0.5 | 7 Blade | | | 56104 | 50002 |
| | Yukon (6 pin taillight plug) | 2007-14 | 41155 | 0.5 | 4 Flat | | | 56104 | 50002 |
| | Yukon (4 pin taillight plug) | 2015 | 40920, 40930, 40940, 40950 40955, 40965, 40975 | 0.5 | 7 Blade | | | | 50002 |
| | Yukon (4 pin taillight plug) | 2015 | 41155 | 0.5 | 4 Flat | | | | 50002 |
| | Yukon (5 pin taillight plug) | 2015 | 40920, 40930, 40940, 40950 40955, 40965, 40975 | 0.5 | 7 Blade | | | | 50002 |
| | Yukon (5 pin taillight plug) | 2015 | 41155 | 0.5 | 4 Flat | | | | 50002 |
| | Yukon (6 pin taillight plug) | 2015 | 40920, 40930, 40940, 40950 40955, 40965, 40975 | 0.5 | 7 Blade | | | | 50002 |
| | Yukon (6 pin taillight plug) | 2015 | 41155 | 0.5 | 4 Flat | | | | 50002 |

| Make | Model | Year | Plug-In Simple! [®] Vehicle Specific Wiring Kit | Est. Install Time Hours | Universal | 5th Wheel Kits | Brake Control Connectors | Towed Vehicle Kits | Plug-In Simple! [®] Camera |
|---------------|---|---------|--|----------------------------------|-----------------|----------------------|--------------------------------|--------------------------|---|
| HONDA | Accord | 1976-93 | N/A | | Converter | | | | |
| | Accord | 1994-02 | 43105 | 1 | Converter | | | | |
| | Accord (2 door) | 2003-05 | 43135 | 1.5 | Power Converter | | | | |
| | Accord (4 door) | 2003-07 | 43195 | 1.5 | Power Converter | | | | |
| | Accord (2 door) | 2006-07 | 43155 | 1.5 | Power Converter | | | | |
| | Accord (2 door & 4 door) | 2008-16 | 43165 | 1.5 | Power Converter | | | | |
| | Accord (2 door & 4 door) (with LED taillights) | 2013-14 | N/A | | Power Converter | | | | |
| | Accord (Wagon) | 1994-97 | 43105 | 1 | Converter | | | | |
| | Accord Crosstour / Crosstour | 2010-12 | 43265 | 1.5 | Power Converter | | | | |
| | Accord Crosstour / Crosstour | 2013-15 | N/A | | Power Converter | | | | |
| | Civic | 1982-95 | N/A | | Power Converter | | | | |
| | Civic | 1996-05 | N/A | | Power Converter | | | | |
| | Civic Hybrid | 2007-10 | N/A | | Power Converter | | | | |
| | Civic (2 door) | 2006-11 | 43175 | 1.5 | Power Converter | | | | |
| | Civic (2 door) | 2013-16 | 43165 | 1.5 | Power Converter | | | | |
| | Civic (4 door) | 2006-11 | 43165 | 1.5 | Power Converter | | | | |
| | Civic (4 door) | 2013-16 | 43165 | 1.5 | Power Converter | | | | |
| | Civic (All) | 2012 | 43185 | 1.5 | Power Converter | | | | |
| | CRV | 1997-06 | 43105 | 0.5 | Converter | | | | |
| | CRV | 2007-11 | 43145 | 1.5 | Power Converter | | | | 56300 |
| | CRV | 2012-15 | 43274 | 1.5 | Power Converter | | | | 56304 |
| | CRZ | 2011-15 | N/A | | Power Converter | | | | |
| | Del Sol | 1993-97 | 43105 | 1 | Converter | | | | |
| | Element | 2003-04 | 43105 | 1 | Converter | | | | |
| | Element | 2005-06 | N/A | | Power Converter | | | | |
| | Element | 2007-12 | 43225 | 1.5 | Power Converter | | | | |
| | Fit | 2007-08 | 43165 | 1.5 | Power Converter | | | | |
| | Fit | 2009-13 | 43165 | 1.5 | Power Converter | | | | 56302 |
| | Odyssey | 1995-04 | 43105 | 1 | Converter | | | | |
| | Odyssey | 2005-10 | 43115 | 1.5 | Power Converter | | | | |
| | Odyssey | 2011-16 | 43114 | 1.5 | Power Converter | | | | |
| | Passport | 1994-97 | 43205 | 1 | Converter | | | | |
| | Passport | 1998-04 | 43215 | 1 | Converter | | | | |
| Pilot | 2003-05 | 43105 | 1 | Converter | | | | | |
| Pilot | 2006-08 | 43105 | 1 | Converter | | | 47935 | | |
| Pilot | 2009-11 | 43104 | 1.5 | Power Converter | | | 47935 | | |
| Pilot | 2012-13 | 43124 | 1.5 | Power Converter | | | 47935 | | |
| Pilot | 2014-15 | 43124 | 1.5 | Power Converter | | | | | |
| Prelude | 1983-00 | N/A | | Power Converter | | | | | |
| Prelude | 2001-02 | 43105 | 1 | Converter | | | | | |
| Ridgeline | 2006-12 | 43125 | 1.5 | Power Converter | | | 47935 | | |
| Ridgeline | 2013-14 | 43125 | 1.5 | Power Converter | | | | | |
| HUMMER | H1 | 2004-06 | N/A | | 4 Flat | | | | |
| | H2 | 2003-07 | 40940, 40950, 40955, 40965, 40975 | 0.5 | 7 Blade | | 47795 | | |
| | H2 | 2003-07 | 41155 | 0.5 | 4 Flat | | 47795 | | |
| | H2 SUT | 2003-07 | 40940, 40950, 40955, 40965, 40975 | 0.5 | 7 Blade | | 47795 | | |
| | H2 SUT | 2003-07 | 41155 | 0.5 | 4 Flat | | 47795 | | |
| | H2 | 2008-09 | 40940, 40950, 40955, 40965, 40975 | 0.5 | 7 Blade | | 47685 | | |
| | H2 | 2008-09 | 41155 | 0.5 | 4 Flat | | 47685 | | |
| | H2 SUT | 2008-09 | 40940, 40950, 40955, 40965, 40975 | 0.5 | 7 Blade | | 47685 | | |
| | H2 SUT | 2008-09 | 41155 | 0.5 | 4 Flat | | 47685 | | |
| | H3 | 2006-09 | 40940, 40950, 40955, 40965, 40975 | 0.5 | 7 Blade | | | | |
| | H3 | 2006-09 | 41155 | 0.5 | 4 Flat | | | | |
| | H3 SUT | 2009 | 40940, 40950, 40955, 40965, 40975 | 0.5 | 7 Blade | | | | |
| | H3 SUT | 2009 | 41155 | 0.5 | 4 Flat | | | | |



| Make | Model | Year | Plug-In Simple! [®] Vehicle Specific Wiring Kit | Est. Install Time Hours | Universal | 5th Wheel Kits | Brake Control Connectors | Towed Vehicle Kits | Plug-In Simple! [®] Camera |
|-------------------------------|--------------------------------|-----------------------------------|--|----------------------------------|-----------------|----------------------|--------------------------------|--------------------------|---|
| HYUNDAI | Accent | 1995-05 | N/A | | Power Converter | | | | |
| | Accent | 2006-11 | 43944 | 1.5 | Power Converter | | | | |
| | Accent (4 door & 5 door) | 2012-15 | 43784 | 1.5 | Power Converter | | | | |
| | Azera | 2006-11 | 43425 | 1.5 | Power Converter | | | | |
| | Azera | 2012-16 | 43804 | 1.5 | Power Converter | | | | |
| | Elantra | 1992-06 | N/A | | Converter | | | | |
| | Elantra | 2007-10 | 43785 | 1.5 | Power Converter | | | | |
| | Elantra Grand Touring | 2009-12 | 43944 | 1.5 | Power Converter | | | | |
| | Elantra Sedan | 2011-16 | 43874 | 1.5 | Power Converter | | | | |
| | Elantra Coupe | 2013-15 | 43814 | 1.5 | Power Converter | | | | |
| | Elantra GT | 2013-16 | 43754 | 1.5 | Power Converter | | | | |
| | Entourage | 2007-08 | 43955 | 1.5 | Power Converter | | | | |
| | Equus | 2011-16 | 43824 | 1.5 | Power Converter | | | | |
| | Excel | 1986-94 | N/A | | Converter | | | | |
| | Genesis (4 door) | 2009-14 | 43765 | 1.5 | Power Converter | | | | |
| | Genesis Coupe (2 door) | 2010-14 | 43994 | 1.5 | Power Converter | | | | |
| | Genesis | 2015 | 43824 | 1.5 | Power Converter | | | | |
| | Santa Fe | 2001-06 | 43805 | 1.5 | Power Converter | | | | |
| | Santa Fe | 2007-12 | 43835 | 1.5 | Power Converter | | | | |
| | Santa Fe (without tow package) | 2013-16 | 43984 | 1.5 | Power Converter | | | | |
| | Santa Fe (with tow package) | 2013-16 | 43965 | 1.5 | Power Converter | | | | |
| | Scoupe | 1991-94 | N/A | | Converter | | | | |
| | Sonata | 1989-05 | N/A | | Power Converter | | | | |
| | Sonata (except Hybrid) | 2006-14 | 43785 | 1.5 | Power Converter | | | | |
| | Sonata Sedan & Hybrid | 2015 | 43874 | 1.5 | Power Converter | | | | |
| | Tiburon | 1992-08 | N/A | | Power Converter | | | | |
| | Tucson | 2005-09 | 43815 | 1 | Converter | | | | |
| | Tucson | 2010-16 | N/A | | Power Converter | | | | |
| | Veloster | 2012-16 | 43834 | 1.5 | Power Converter | | | | |
| | Veracruz | 2007-09 | 43995 | 1.5 | Power Converter | | | | |
| Veracruz (with tow package) | 2010-13 | 43965 | 1.5 | Power Converter | | | | | |
| XG 300 | 2001-02 | N/A | | Power Converter | | | | | |
| XG 350 | 2004-05 | N/A | | Power Converter | | | | | |
| INFINITI | EX35 | 2004-09 | N/A | | Power Converter | | | | |
| | EX35, EX50, QX50 | 2010-14 | N/A | | Power Converter | | | | |
| | FX 35 | 2005-10 | N/A | | Power Converter | | | | |
| | FX 35 | 2009-13 | 40805 | 1.5 | Power Converter | | | | |
| | FX 37, QX70 | 2009-16 | 40805 | 1.5 | Power Converter | | | | |
| | FX 45 | 2004-06 | 40804 | 1.5 | Power Converter | | | | |
| | FX 50, QX70 | 2009-15 | 40805 | 1.5 | Power Converter | | | | |
| | G20 | 1991-96 | N/A | | Power Converter | | | | |
| | G20 | 1999-01 | N/A | | Power Converter | | | | |
| | G25X Sedan | 2010-13 | 40825 | 1.5 | Power Converter | | | | |
| | G35 | 2007-08 | 43645 | 1.5 | Power Converter | | | | |
| | G37 | 2008-09 | N/A | | Power Converter | | | | |
| | G37 Sedan, Q50 | 2009-15 | 40825 | 1.5 | Power Converter | | | | |
| | I30 | 1995-01 | N/A | | Power Converter | | | | |
| | I35 | 2003-05 | N/A | | Power Converter | | | | |
| | J30 | 1993-98 | N/A | | Power Converter | | | | |
| | J35, QX60 | 2013-15 | N/A | | Power Converter | | | | |
| | M35 | 2006-10 | N/A | | Power Converter | | | | |
| | M35H, Q70 | 2012-15 | N/A | | Power Converter | | | | |
| | M37, Q70 | 2011-15 | N/A | | Power Converter | | | | |
| | M45 | 2005-10 | N/A | | Power Converter | | | | |
| | M56 | 2011 | N/A | | Power Converter | | | | |
| | Q45 | 1989-01 | N/A | | Power Converter | | | | |
| | Q45 | 2005-06 | N/A | | Power Converter | | | | |
| QX4 | 1996-03 | 43565 | 1.5 | Power Converter | | | | | |
| QX56 (with tow package), QX80 | 2004-15 | 40940, 40950, 40955, 40965, 40975 | 0.5 | 7 Blade | | 47635 | | | |
| QX56 (with tow package), QX80 | 2004-15 | 41155 | 0.5 | 4 Flat | | 47635 | | | |

| Make | Model | Year | Plug-In Simple! [®] Vehicle Specific Wiring Kit | Est. Install Time Hours | Universal | 5th Wheel Kits | Brake Control Connectors | Towed Vehicle Kits | Plug-In Simple! [®] Camera |
|---------------|---------------------|---------|--|----------------------------------|-----------------|----------------------|--------------------------------|--------------------------|---|
| ISUZU | Ascender | 2003 | 43105 | 1 | Converter | | | | |
| | Ascender | 2004-08 | 40920, 40930, 40940, 40950 40955, 40965, 40975 | 0.5 | 7 Blade | | | | |
| | Ascender | 2004-08 | 41155 | 0.5 | 4 Flat | | | | |
| | Amigo / Rodeo Sport | 1989-94 | N/A | | Converter | | | | |
| | Amigo | 1998-01 | 43215 | 1 | Converter | | | | |
| | Axiom | 2002-04 | 43215 | 1 | Converter | | | | |
| | Cyclone | 1991-92 | 41115 | 1 | 4 Flat | | | | |
| | Hombre | 1996-97 | 41115 | 0.5 | 4 Flat | | | | |
| | Hombre | 1998-01 | 41135 | 0.5 | 4 Flat | | | | |
| | Impulse | 1983-93 | N/A | | Power Converter | | | | |
| | I-280 | 2006 | 41165 | 1.5 | Power Converter | | | | |
| | I-290 | 2007-08 | 41165 | 1.5 | Power Converter | | | | |
| | I-350 | 2004-05 | N/A | | Power Converter | | | 56109 | |
| | I-350 | 2006 | 41165 | 1.5 | Power Converter | | | 56109 | |
| | I-350 | 2007-11 | N/A | | Power Converter | | | 56109 | |
| | I-370 | 2007-08 | 41165 | 1.5 | Power Converter | | | | |
| | J-Mark | 1981-89 | N/A | | Converter | | | | |
| | Oasis | 1996-98 | 43105 | 1 | Converter | | | | |
| | Pickup | 1981-88 | N/A | | Converter | | | | |
| | Pickup | 1989-95 | 43285 | 0.5 | Converter | | | | |
| Rodeo | 1992-97 | 43205 | 0.5 | Converter | | | | | |
| Rodeo | 1998-04 | 43215 | 0.5 | Converter | | | | | |
| Stylus | 1991-93 | N/A | | Converter | | | | | |
| Trooper | 1988-91 | N/A | | Converter | | | | | |
| Trooper | 1992-02 | 43255 | 0.5 | Converter | | | | | |
| Vehicross | 1999-01 | N/A | | Converter | | | | | |
| JAGUAR | S-Type | 2004-07 | N/A | | Power Converter | | | | |
| | X-Type | 2005-06 | N/A | | Power Converter | | | | |
| | X-Type | 2007-09 | N/A | | Power Converter | | | | |
| | XK | 2007 | N/A | | Power Converter | | | | |
| | XJ8 | 2000 | N/A | | Power Converter | | | | |
| | XJ8 | 2004 | N/A | | Power Converter | | | | |
| | X-Type AWD | 2004 | N/A | | Power Converter | | | | |





JEEP

| Make | Model | Year | Plug-In Simple! [®] Vehicle Specific Wiring Kit | Est. Install Time Hours | Universal | 5th Wheel Kits | Brake Control Connectors | Towed Vehicle Kits | Plug-In Simple! [®] Camera |
|------|--|---------|--|----------------------------------|-----------------|----------------------|--------------------------------|--------------------------|---|
| | Cherokee | 1976-82 | N/A | | 4 Flat | | | | |
| | Cherokee | 1983-90 | N/A | | Converter | | | | |
| | Cherokee | 1991-96 | 42455 | 0.5 | Converter | | | | |
| | Cherokee | 1997-01 | 42465 | 0.5 | Converter | | | | |
| | Cherokee | 2014-16 | 42464 | 1.5 | Power Converter | | | | |
| | Cherokee (with tow package) | 2014-16 | 40940, 40950, 40955, 40965, 40975 | 0.5 | 7 Blade | | | | |
| | Cherokee (with tow package) | 2014-16 | 41155 | 0.5 | 4 Flat | | | | |
| | CJ-5, CJ-7, Scrambler | 1977-86 | N/A | | 4 Flat | | | | |
| | Comanche | 1986-92 | N/A | | 4 Flat | | | | |
| | Commander | 2006-10 | 42705 | 1.5 | Power Converter | | | 56205 | |
| | Commander (with tow package) | 2006-10 | 42145, 42190 | 0.5 | 7 Blade | | | 56205 | |
| | Compass | 2007-10 | 42125 | 1.5 | Power Converter | | | | |
| | Compass | 2011-16 | 42645 | 1.5 | Power Converter | | | | |
| | Grand Wagoneer | 1984-91 | N/A | | Converter | | | | |
| | Grand Cherokee (mfg. 8/92-2/94) | 1993 | N/A | | Power Converter | | | | |
| | Grand Cherokee (mfg. 3/94-1998) | 1994-98 | 42515 | 1.5 | Power Converter | | | | |
| | Grand Cherokee (with tow package) | 1995-98 | 42525 | 1.5 | Power Converter | | | | |
| | Grand Cherokee (without tow package) | 1999-04 | 42535 | 1.5 | Power Converter | | | | |
| | Grand Cherokee (with factory 4 flat) | 2000-04 | 42565 | 0.5 | 4 Flat | | | | |
| | Grand Cherokee (with tow package) | 2000-04 | 42145, 42190 | 0.5 | 7 Blade | | | | |
| | Grand Cherokee (early 07) | 2005-07 | 42545 | 1.5 | Power Converter | | | 56206 | |
| | Grand Cherokee (with factory 4 flat) (early 07) | 2005-07 | 42565 | 0.5 | 4 Flat | | | 56206 | |
| | Grand Cherokee (with tow package) (early 07) | 2005-07 | 42145, 42190 | 0.5 | 7 Blade | | | 56206 | |
| | Grand Cherokee (with factory 4 flat) | 2007-10 | 42565 | 0.5 | 4 Flat | | | 56207 | |
| | Grand Cherokee (with tow package) | 2007-10 | 42145, 42190 | 0.5 | 7 Blade | | | 56207 | |
| | Grand Cherokee (without tow package) | 2007-11 | 42555 | 0.5 | 4 Flat | | | 56207 | |
| | Grand Cherokee (with tow package) | 2011-15 | 40940, 40950, 40955, 40965, 40975 | 0.5 | 7 Blade | | 53035 | | |
| | Grand Cherokee (with tow package) | 2011-15 | 41155 | 0.5 | 4 Flat | | 53035 | | |
| | Grand Cherokee | 2012-15 | N/A | | Power Converter | | | | |
| | J-10, J-20 Pickup | 1972-88 | N/A | | 4 Flat | | | | |
| | Liberty | 2002-07 | 42475 | 1.5 | Power Converter | | | 56203 | |
| | Liberty (with tow package) | 2004-07 | 42145, 42190 | 0.5 | 7 Blade | | | 56203 | |
| | Liberty | 2008-12 | 42485 | 1.5 | Power Converter | | | 56204 | |
| | Liberty (with tow package) | 2008-10 | 40940, 40950, 40955, 40965, 40975 | 0.5 | 7 Blade | | | 56204 | |
| | Liberty (with tow package) | 2008-10 | 41155 | 0.5 | 4 Flat | | | 56204 | |
| | Patriot (without tow package) | 2007 | 42125 | 1.5 | Power Converter | | | | |
| | Patriot (without tow package) | 2008-16 | 42175 | 1.5 | Power Converter | | | | |
| | Renegade | 2015-16 | N/A | | Power Converter | | | | |
| | Wagoneer | 1972-90 | N/A | | 4 Flat | | | | |
| | Wrangler / Renegade | 1987-90 | N/A | | 4 Flat | | | | |
| | Wrangler / Renegade | 1991-97 | 42605 | 0.5 | 4 Flat | | | | |
| | Wrangler / Renegade | 1998-04 | 42615 | 1.5 | 4 Flat | | | 56202 | |
| | Wrangler / Renegade | 2005-06 | 42625 | 0.5 | 4 Flat | | | 56202 | |
| | Wrangler / Renegade (with tow package) | 2004-06 | 42145, 42190 | 0.5 | 7 Blade | | | 56202 | |
| | Wrangler | 2007-16 | 42635 | 0.5 | 4 Flat | | | 56200 | |
| | Wrangler / Renegade (with tow package) | 2007-16 | 42145, 42190 | 0.5 | 7 Blade | | | 56200 | |

| Make | Model | Year | Plug-In Simple! [®] Vehicle Specific Wiring Kit | Est. Install Time Hours | Universal | 5th Wheel Kits | Brake Control Connectors | Towed Vehicle Kits | Plug-In Simple! [®] Camera |
|------------|---|---------|--|----------------------------------|-----------------|----------------------|--------------------------------|--------------------------|---|
| KIA | Amanti | 2004-06 | N/A | | Power Converter | | | | |
| | Amanti | 2007-09 | 43905 | 1.5 | Power Converter | | | | |
| | Borrego (with tow package) | 2009 | 40940, 40950, 40955, 40965, 40975 | 0.5 | 7 Blade | | | | |
| | Borrego (with tow package) | 2009 | 41155 | 0.5 | 4 Flat | | | | |
| | Cadenza | 2014-16 | 43900 | 1.5 | Power Converter | | | | |
| | Forte (4 door) | 2010-12 | 43835 | 1.5 | Power Converter | | | | |
| | Forte (5 door) | 2010-13 | 43895 | 1.5 | Power Converter | | | | |
| | Forte | 2014-16 | 43825 | 1.5 | Power Converter | | | | |
| | K900 | 2015 | 43874 | 1.5 | Power Converter | | | | |
| | Optima | 2003-07 | N/A | | Power Converter | | | | |
| | Optima | 2007-08 | 43935 | 1 | 4 Flat | | | | |
| | Optima | 2010-15 | N/A | | Power Converter | | | | |
| | Rio 4 door | 2005-12 | 43934 | 1.5 | Power Converter | | | | |
| | Rio 5 door | 2005-12 | 43944 | 1.5 | Power Converter | | | | |
| | Rio 4 door (Late 2012) | 2012-15 | 43954 | 1.5 | Power Converter | | | | |
| | Rio 5 door Hatchback (Late 2012) | 2012-16 | 43964 | 1.5 | Power Converter | | | | |
| | Rondo | 2007-09 | 43975 | 1.5 | Power Converter | | | | |
| | Sedona | 2002-05 | 43945 | 1.5 | Power Converter | | | | |
| | Sedona | 2006-15 | 43955 | 1.5 | Power Converter | | | | |
| | Sephia | 1994-02 | N/A | | Converter | | | | |
| | Sorento | 2003-06 | 43985 | 1 | Converter | | | | |
| | Sorento | 2007-09 | 43995 | 1.5 | Power Converter | | | | |
| | Sorento LX / EX 4 cyl. (No SX) | 2011-13 | 43914 | 1.5 | Power Converter | | | | |
| | Sorento I4, V6 (without tow package) | 2014-16 | 43820 | 1.5 | Power Converter | | | | |
| | Sorento EX/LX V6 only (No SX) (with tow package) | 2011-16 | 43965 | 1.5 | Power Converter | | | | |
| | Soul | 2010-16 | 43975 | 1 | Converter | | | | |
| Spectra | 2004-09 | 43924 | 1.5 | Power Converter | | | | | |
| Sportage | 1998-02 | 43915 | 0.5 | Converter | | | | | |
| Sportage | 2005-06 | 43925 | 0.5 | Converter | | | | | |
| Sportage | 2007-10 | N/A | | Power Converter | | | | | |
| Sportage | 2011-16 | 43795 | 1.5 | Power Converter | | | | | |
| LAND ROVER | CR3 | 2005-06 | N/A | | Power Converter | | | | |
| | Defender | 1993-98 | N/A | | Power Converter | | | | |
| | Discovery | 1994-01 | N/A | | Power Converter | | | | |
| | Discovery Sport | 2004-07 | N/A | | Power Converter | | | | |
| | Freelander | 2005-06 | N/A | | Power Converter | | | | |
| | LR2 | 2008-10 | N/A | | Power Converter | | | | |
| | LR3 | 2005-09 | N/A | | Power Converter | | 47715 | | |
| | LR3 | 2010 | N/A | | Power Converter | | 47715 | | |
| LR4 | 2010-14 | N/A | | Power Converter | | 47715 | | | |
| LEXUS | Evoque | 2012-13 | N/A | | See Dealer | | | | |
| | Range Rover | 1987-01 | N/A | | Power Converter | | | | |
| | Range Rover | 2004 | N/A | | Power Converter | | | | |
| | Range Rover HSE | 2005-09 | N/A | | Power Converter | | 47715 | | |
| | Range Rover | 2010-15 | N/A | | See Dealer | | 47715 | | |
| | Range Rover (with tow package) | 2013-14 | 40940, 40950, 40955, 40965, 40975 | 0.5 | 7 Blade | | | | |
| | Range Rover (with tow package) | 2013-14 | 41155 | 0.5 | 4 Flat | | | | |
| | LR4 (with tow package) | 2013-14 | 40940, 40950, 40955, 40965, 40975 | 0.5 | 7 Blade | | | | |
| | LR4 (with tow package) | 2013-14 | 41155 | 0.5 | 4 Flat | | | | |
| | CT200H | 2010-16 | 41915 | 1.5 | Power Converter | | | | |
| | ES 300 | 1991-01 | N/A | | Power Converter | | | | |
| | ES 300 | 2002-03 | N/A | | Power Converter | | | | |
| | ES 300 | 2013-16 | 41940 | 1.5 | Power Converter | | | | |
| | ES 330 | 2004-06 | N/A | | Power Converter | | | | |
| | ES 350 | 2007-12 | 41930 | 1.5 | Power Converter | | | | |
| | ES 350 | 2013-16 | 41940 | 1.5 | Power Converter | | | | |
| | GS 300 | 1991-01 | N/A | | Power Converter | | | | |
| | GS 300 | 2004-06 | N/A | | Power Converter | | | | |
| | GS 300 | 2006-11 | N/A | | Power Converter | | | | |
| GS 300 | 2012-16 | N/A | | Power Converter | | | | | |
| GS 350 | 2007-11 | N/A | | Power Converter | | | | | |
| GS 350 | 2012-16 | N/A | | Power Converter | | | | | |
| GS 430 | 2004-11 | N/A | | Power Converter | | | | | |

| Make | Model | Year | Plug-In Simple! [®] Vehicle Specific Wiring Kit | Est. Install Time Hours | Universal | 5th Wheel Kits | Brake Control Connectors | Towed Vehicle Kits | Plug-In Simple! [®] Camera |
|---------------------------|--------------------------------|-----------------------------------|--|----------------------------------|--------------------------|----------------------|--------------------------------|--------------------------|---|
| LEXUS | GS 450H | 2007-11 | N/A | | Power Converter | | | | |
| | GS 450H | 2012-16 | N/A | | Power Converter | | | | |
| | GS 460 | 2008-11 | N/A | | Power Converter | | | | |
| | GX460 | 2010-13 | 41920 | 1 | Power Converter | | 47815 | | |
| | GX470 | 2000-09 | N/A | | Power Converter | | | | |
| | GX470 (with tow package) | 2003 | 43374 | 0.5 | Power Converter | | 47815 | | |
| | GX470 (with tow package) | 2004-09 | 43374 | 0.5 | Power Converter | | 47815 | | |
| | GX470 (with tow package) | 2010 | N/A | | Power Converter | | 47815 | | |
| | HS 250H | 2010-16 | 41915 | 1.5 | Power Converter | | | | |
| | IS 250 | 2007-15 | N/A | | Power Converter | | | | |
| | IS 300 | 2004-13 | N/A | | Power Converter | | | | |
| | IS 350 | 2007-15 | N/A | | Power Converter | | | | |
| | IS-F | 2008-13 | N/A | | Power Converter | | | | |
| | LS 400 / 430 | 1991-01 | N/A | | Power Converter | | | | |
| | LS 430 | 2004-14 | N/A | | Power Converter | | | | |
| | LS 460 | 2007-14 | N/A | | Power Converter | | | | |
| | LS 600H | 2008-13 | 41925 | 1.5 | Power Converter | | | | |
| | LX 450 | 1996-98 | 43405 | 1 | Converter | | | | |
| | LX 470 (without tow package) | 1999-01 | N/A | | Power Converter | | | | |
| | LX 470 (with factory 4 flat) | 2001-07 | 41875 | 1.5 | Power Converter | | | | |
| | LX 470 (without tow package) | 2004-07 | N/A | | Power Converter | | | | |
| | LX 570 | 2008-11 | 43910 | 1.5 | Power Converter | | 47815 | | |
| | LX 570 | 2012 | 43910 | 1.5 | Power Converter | | | | |
| | LX 570 | 2013 | 43910 | 1.5 | Power Converter | | 47815 | | |
| | RX 300 (without tow package) | 1999-01 | N/A | | Power Converter | | | | |
| | RX 300 (with factory 4 flat) | 2001-03 | 41875 | 1.5 | Power Converter | | | | |
| | RX 300 | 2002-03 | N/A | | Converter | | | | |
| | RX 330 | 2004-06 | 41905 | 1.5 | Power Converter | | | | |
| | RX 350 | 2007-12 | 41905 | 1.5 | Power Converter | | | | |
| | RX 350 (with tow package) | 2010-15 | 41945 | 1.5 | Power Converter | | | | |
| | RX 350 | 2013-14 | N/A | | Power Converter | | | | |
| | RX 400 | 2006-08 | 41935 | 1.5 | Power Converter | | | | |
| RX 400H | 2006 | N/A | | Converter | | | | | |
| RX 450H | 2009-10 | N/A | | Power Converter | | | | | |
| RX 450 (with tow package) | 2010-15 | 41945 | 1.5 | Power Converter | | | | | |
| SC 300 / 400 | 1991-00 | N/A | | Power Converter | | | | | |
| SC 430 | 2003-13 | N/A | | Power Converter | | | | | |
| LINCOLN | Aviator (without tow package) | 1998-03 | 40655 | 0.5 | 4 Flat | | | | |
| | Aviator (without tow package) | 2003-04 | 40655 | 0.5 | 4 Flat | | | | |
| | Aviator (with factory 4 flat) | 2003-05 | 40335 | 0.5 | 4 Flat | | 47715 | | |
| | Aviator | 2006 | 40345 | 0.5 | 4 Flat | | | | |
| | Aviator (with factory 7 blade) | 2003-05 | 40940, 40950, 40955, 40965, 40975 | 0.5 | 7 Blade | | 47715 | | 50002 |
| | Aviator (with factory 7 blade) | 2003-05 | 41155 | 0.5 | 4 Flat | | 47715 | | 50002 |
| | Aviator (with factory 7 blade) | 2006 | 40940, 40950, 40955, 40965, 40975 | 0.5 | 7 Blade | | | | 50002 |
| | Aviator (with factory 7 blade) | 2006 | 41155 | 0.5 | 4 Flat | | | | 50002 |
| | Continental | 1974-87 | N/A | | 4 Flat | | | | |
| | Continental | 1988-02 | N/A | | Power Converter | | | | |
| | LS | 2000-06 | 40355 | 1.5 | Negative Power Converter | | | | |
| | Mark LT | 2006 | 40940, 40950, 40955, 40965, 40975 | 0.5 | 7 Blade | | | 56005 | 50002 |
| | Mark LT | 2006 | 41155 | 0.5 | 4 Flat | | | 56005 | 50002 |
| | Mark LT | 2007-08 | 40940, 40950, 40955, 40965, 40975 | 0.5 | 7 Blade | | 47715 | 56005 | 50002 |
| | Mark LT | 2007-08 | 41155 | 0.5 | 4 Flat | | 47715 | 56005 | 50002 |
| | Mark VI | 1980-83 | N/A | | 4 Flat | | | | |
| | Mark VII | 1984-92 | N/A | | Power Converter | | | | |
| | Mark VIII | 1993-98 | N/A | | Power Converter | | | | |
| | MKC | 2015-16 | N/A | | Power Converter | | | | |
| | MKS | 2009-15 | 40375 | 1.5 | Power Converter | | | | |
| | MKT (without tow package) | 2009 | 40385 | 1.5 | Power Converter | | | | |
| | MKT (with tow package) | 2009 | 40940, 40950, 40955, 40965, 40975 | 0.5 | 7 Blade | | | | |
| MKT (with tow package) | 2009 | 41155 | 0.5 | 4 Flat | | | | | |
| MKT (without tow package) | 2010-11 | 40385 | 1.5 | Power Converter | | 47715 | | | |
| MKT (with tow package) | 2010-11 | 40940, 40950, 40955, 40965, 40975 | 0.5 | 7 Blade | | 47715 | | | |
| MKT (with tow package) | 2010-11 | 41155 | 0.5 | 4 Flat | | 47715 | | | |
| MKT (without tow package) | 2012-14 | 40385 | 1.5 | Power Converter | | 47845 | | | |

| Make | Model | Year | Plug-In Simple! [®] Vehicle Specific Wiring Kit | Est. Install Time Hours | Universal | 5th Wheel Kits | Brake Control Connectors | Towed Vehicle Kits | Plug-In Simple! [®] Camera |
|-------------------------------|--------------------------------|---------|--|----------------------------------|-----------------|----------------------|--------------------------------|--------------------------|---|
| LINCOLN | MKT (with tow package) | 2012-14 | 40940, 40950, 40955, 40965, 40975 | 0.5 | 7 Blade | | 47845 | | |
| | MKT (with tow package) | 2012-14 | 41155 | 0.5 | 4 Flat | | 47845 | | |
| | MKT (without tow package) | 2015 | N/A | 1.5 | Power Converter | | 47845 | | |
| | MKT (with tow package) | 2015 | N/A | 0.5 | 7 Blade | | 47845 | | |
| | MKT (with tow package) | 2015 | N/A | 0.5 | 4 Flat | | 47845 | | |
| | MKX | 2007-10 | 40495 | 1.5 | Power Converter | | | 56000 | |
| | MKX | 2011-16 | 40314 | 1.5 | Power Converter | | | 56002 | |
| | MKZ | 2007-09 | 40395 | 1.5 | Power Converter | | | | |
| | MKZ | 2013-16 | 40324 | 1.5 | Power Converter | | | | |
| | Navigator | 1997 | 40135 | 0.5 | 4 Flat | | | | |
| | Navigator | 1998-99 | 40135 | 0.5 | 4 Flat | | 47715 | | |
| | Navigator | 2000-02 | 40925 | 0.5 | 4 Flat | | 47715 | | |
| | Navigator | 2003-12 | 40495 | 1.5 | 4 Flat | | 47715 | | |
| | Navigator (with tow package) | 1999-12 | 40940, 40950, 40955, 40965, 40975 | 0.5 | 7 Blade | | 47715 | | |
| | Navigator (with tow package) | 1999-12 | 41155 | 0.5 | 4 Flat | | 47715 | | |
| | Navigator | 2013-14 | 40495 | 1.5 | 4 Flat | | 47855 | | |
| | Navigator (with tow package) | 2013-15 | 40940, 40950, 40955, 40965, 40975 | 0.5 | 7 Blade | | 47855 | | |
| | Navigator (with tow package) | 2013-15 | 41155 | 0.5 | 4 Flat | | 47855 | | |
| | Navigator | 2015 | 40495 | 0.5 | 4 Flat | | | | |
| | Town Car | 1980-97 | N/A | | 4 Flat | | | | |
| Town Car | 1998-04 | 40505 | 1 | 4 Flat | | | | | |
| Town Car | 2005-10 | N/A | | Power Converter | | | | | |
| Zephyr | 2006 | N/A | | Power Converter | | | | | |
| MAZDA | 2 | 2011-14 | 43165 | 1.5 | Power Converter | | | | |
| | 3 | 2004-13 | 43165 | 1.5 | Power Converter | | | | |
| | 3 | 2014-15 | 41824 | 1.5 | Power Converter | | | | |
| | 5 | 2006-15 | 40265 | 1.5 | Power Converter | | | | |
| | 6 | 2003-08 | 41824 | 1.5 | Power Converter | | | | |
| | 6 | 2009-13 | 40245 | 1.5 | Power Converter | | | | |
| | 6 | 2014-16 | 40254 | 1.5 | Power Converter | | | | |
| | 323 | 1987-94 | N/A | | Power Converter | | | | |
| | 626 | 1979-87 | N/A | | Converter | | | | |
| | 626 | 1988-02 | N/A | | Power Converter | | | | |
| | 929 | 1988-96 | N/A | | Power Converter | | | | |
| | CX-5 | 2013-16 | 43165 | 1.5 | Power Converter | | | | |
| | CX-7 | 2007-09 | 41824 | 1.5 | Power Converter | | | | |
| | CX-9 | 2007-14 | 40265 | 1.5 | Power Converter | | | | |
| | GLC | 1977-86 | N/A | | Converter | | | | |
| | Miata | 1990 | 43755 | 1 | Converter | | | | |
| | Miata | 1993-02 | N/A | | Power Converter | | | | |
| | Miata MX-5 | 1999-05 | 40235 | 1.5 | Power Converter | | | | |
| | Miata MX-5 | 2006-14 | 41824 | 1.5 | Power Converter | | | | |
| | Millenia | 1995-02 | N/A | | Power Converter | | | | |
| | MPV Van | 1989-99 | N/A | | Power Converter | | | | |
| | MPV Van | 2000-06 | 40235 | 1.5 | Power Converter | | | | |
| | MX-3 | 1992-96 | N/A | | Power Converter | | | | |
| | MX-6 | 1988-97 | N/A | | Power Converter | | | | |
| | Navajo | 1991-94 | 40305 | 1 | 4 Flat | | | | |
| | Navajo (with tow package) | 1991-94 | 40905 | 0.5 | 4 Flat | | | | |
| | Pickup B-Series | 1985-93 | 43755 | 0.5 | Converter | | | | |
| | Pickup B-Series | 1994-97 | 40215 | 0.5 | Converter | | | | |
| | Pickup B-Series | 1998-09 | 40215 | 0.5 | Converter | | | 56003 | |
| | PU B-Series (with tow package) | 1998-99 | 40915 | 0.5 | 4 Flat | | | | |
| | Protege | 1991-03 | N/A | | Power Converter | | | | |
| | RX7 | 1979-95 | N/A | | Power Converter | | | | |
| | RX8 | 2005-07 | N/A | | Power Converter | | | | |
| | RX8 | 2008-10 | N/A | | Power Converter | | | | |
| | Tribute | 2001-03 | 40315 | 1.5 | Power Converter | | | | |
| | Tribute (with tow package) | 2001-04 | 40445 | 0.5 | 4 Flat | | | | |
| Tribute (without tow package) | 2005-06 | 40465 | 1.5 | Power Converter | | | | | |
| Tribute (with tow package) | 2005-06 | 40455 | 1.5 | Power Converter | | | | | |
| Tribute | 2008-11 | 40495 | 1.5 | Power Converter | | | 56000 | | |



| Make | Model | Year | Plug-In Simple! [®] Vehicle Specific Wiring Kit | Est. Install Time Hours | Universal | 5th Wheel Kits | Brake Control Connectors | Towed Vehicle Kits | Plug-In Simple! [®] Camera |
|----------------------------|---------------------------------------|---------|--|----------------------------------|-----------------|----------------------|--------------------------------|--------------------------|---|
| MERCEDES BENZ | C Class Exc Wagon | 1994-07 | N/A | | Power Converter | | | | |
| | C Class Exc Wagon | 2008-15 | N/A | | See Dealer | | | | |
| | C Class Wagon | 2002-05 | N/A | | Power Converter | | | | |
| | CLA | 2013-15 | N/A | | See Dealer | | | | |
| | CLK | 1989-02 | N/A | | Power Converter | | | | |
| | CLK Class | 2003-09 | N/A | | Power Converter | | | | |
| | CLS Class | 2010 | N/A | | See Dealer | | | | |
| | E Class Exc Wagon | 1994-09 | N/A | | Power Converter | | | | |
| | E Class Wagon | 2004-08 | N/A | | See Dealer | | | | |
| | E Class Wagon | 2010 | N/A | | See Dealer | | | | |
| | E Class | 2011-15 | N/A | | See Dealer | | | | |
| | G Class | 2002-10 | N/A | | See Dealer | | | | |
| | G Class | 2012-15 | N/A | | See Dealer | | | | |
| | GL Class (with tow package) | 2007-10 | 42145, 42190 | 1.5 | 7 Blade | | | | |
| | GL Class (with tow pkg) | 2011-15 | N/A | | 7 Blade | | | | |
| | GL Class (without tow package) | 2007-15 | N/A | | Power Converter | | | | |
| | GLK Class (without tow package) | 2010-15 | N/A | | See Dealer | | | | |
| | GLK Class (with tow package) | 2013-15 | N/A | | 7 Blade | | | | |
| | M Class (without tow package) | 1998-05 | N/A | | Power Converter | | | | |
| | M Class (with tow package) | 1998-05 | 40940, 40950, 40955, 40965, 40975 | 0.5 | 7 Blade | | | | |
| | M Class (with tow package) | 1998-05 | 41155 | 0.5 | 4 Flat | | | | |
| | M Class (without tow package) | 2006-08 | N/A | | Power Converter | | | | |
| | M Class (with tow package) | 2006-08 | 40940, 40950, 40955, 40965, 40975 | 0.5 | 7 Blade | | | | |
| | M Class (with tow package) | 2006-08 | 41155 | 0.5 | 4 Flat | | | | |
| | M Class (without tow package) | 2009-14 | N/A | | Power Converter | | | | |
| | M Class (with tow package) | 2009-14 | 40940, 40950, 40955, 40965, 40975 | 0.5 | 7 Blade | | | | |
| M Class (with tow package) | 2009-14 | 41155 | 0.5 | 4 Flat | | | | | |
| R Class | 2006-10 | N/A | | See Dealer | | | | | |
| S Class | 1992-06 | N/A | | Power Converter | | | | | |
| MERCURY | S Class | 2007-10 | N/A | | See Dealer | | | | |
| | SL Class | 1992-11 | N/A | | See Dealer | | | | |
| | SLR Class | 2006-10 | N/A | | See Dealer | | | | |
| | Sprinter Van | 2010-13 | N/A | | Power Converter | | | | |
| | Capri | 1979-86 | N/A | | Converter | | | | |
| | Cougar | 1974-88 | N/A | | 4 Flat | | | | |
| | Cougar | 1989-97 | N/A | | Power Converter | | | | |
| | Cougar | 1999-02 | N/A | | Power Converter | | | | |
| | Grand Marquis | 1983-91 | N/A | | 4 Flat | | | | |
| | Grand Marquis | 1992-97 | 40505 | 1 | 4 Flat | | | | |
| | Grand Marquis | 1998-10 | N/A | | Power Converter | | | | |
| | Grand Marquis Wagon | 1983-91 | N/A | | Power Converter | | | | |
| | LN7 | 1982-83 | N/A | | 4 Flat | | | | |
| | Lynx | 1981-87 | N/A | | Power Converter | | | | |
| | Marauder | 2003-04 | N/A | | Power Converter | | | | |
| | Mariner (with tow package) | 2005-07 | 40455 | 0.5 | 4 Flat | | | | |
| | Mariner | 2005-11 | 40495 | 1.5 | Power Converter | | | | |
| | Marquis | 1974-86 | N/A | | 4 Flat | | | | |
| | Milan | 2007-10 | 40395 | 1.5 | Power Converter | | | | |
| | Monarch | 1975-80 | N/A | | 4 Flat | | | | |
| | Montego | 1974-76 | N/A | | 4 Flat | | | | |
| | Montego | 2005-07 | N/A | | Converter | | | | |
| | Monterey* | 2005-07 | N/A | | Power Converter | | | | |
| | Mountaineer (without tow package) | 2002-03 | 40655 | 0.5 | 4 Flat | | | | |
| | Mountaineer | 1996-97 | 40325 | 0.5 | 4 Flat | | | | |
| | Mountaineer | 1997-00 | 40315 | 1.5 | Power Converter | | | | |
| | Mountaineer (with tow package) | 1996-99 | 40915 | 0.5 | 4 Flat | | | | |
| | Mountaineer (with tow package) | 2000-01 | 40915 | 0.5 | 4 Flat | | | | |
| | Mountaineer (with factory 4 flat) | 2002-05 | 40335 | 0.5 | 4 Flat | | | 47715 | |
| | Mountaineer | 2006-10 | 40345 | 0.5 | 4 Flat | | | 47715 | |
| | Mountaineer (with factory 7 blade) | 2002-10 | 40940, 40950, 40955, 40965, 40975 | 0.5 | 7 Blade | | | 47715 | |
| | Mountaineer (with factory 7 blade) | 2002-10 | 41155 | 0.5 | 4 Flat | | | 47715 | |
| Mystique | 1995-00 | N/A | | 4 Flat | | | | | |

| Make | Model | Year | Plug-In Simple! [®] Vehicle Specific Wiring Kit | Est. Install Time Hours | Universal | 5th Wheel Kits | Brake Control Connectors | Towed Vehicle Kits | Plug-In Simple! [®] Camera |
|---------------------------|--|--------------|--|----------------------------------|-----------------|----------------------|--------------------------------|--------------------------|---|
| MERCURY | Sable | 1984-91 | N/A | | Converter | | | | |
| | Sable | 1992-95 | N/A | | 4 Flat | | | | |
| | Sable (Sedan) | 1996-99 | 40565 | 1 | Converter | | | | |
| | Sable (Sedan) | 2000-03 | 40575 | 1 | Converter | | | | |
| | Sable (Sedan) | 2004-05 | N/A | | Converter | | | | |
| | Sable (Sedan) | 2008-09 | 40585 | 1.5 | Power Converter | | | | |
| | Sable (Wagon) | 1986-95 | N/A | | 4 Flat | | | | |
| | Sable (Wagon) | 1996-01 | N/A | | Converter | | | | |
| | Topaz | 1984-87 | N/A | | 4 Flat | | | | |
| | Topaz | 1988-95 | N/A | | Power Converter | | | | |
| | Tracer | 1988-96 | N/A | | Power Converter | | | | |
| | Tracer | 1997-99 | 40655 | 1 | 4 Flat | | | | |
| | Villager | 1993-02 | N/A | | Converter | | | | |
| Zephyr | 1978-83 | N/A | | 4 Flat | | | | | |
| MINI | Countryman | 2015 | N/A | | See Dealer | | | | |
| | Coupe | 2015 | N/A | | See Dealer | | | | |
| | Convertible | 2015 | N/A | | See Dealer | | | | |
| | Clubman | 2015 | N/A | | See Dealer | | | | |
| | Cooper | 2015 | N/A | | See Dealer | | | | |
| | Cooper Paceman | 2015 | N/A | | See Dealer | | | | |
| | Cooper Roadster | 2015 | N/A | | See Dealer | | | | |
| MITSUBISHI | 3000 GT | 1991-99 | N/A | | Power Converter | | | | |
| | Diamante | 1992-05 | N/A | | Power Converter | | | | |
| | Eclipse | 1990-10 | N/A | | Power Converter | | | | |
| | Endeavor | 2003-12 | 42375 | 1.5 | Power Converter | | | | |
| | Expo LVR | 1992-94 | N/A | | Converter | | | | |
| | Galant | 1985-13 | N/A | | Power Converter | | | | |
| | Lancer | 2002-15 | N/A | | Power Converter | | | | |
| | Mirage | 1985-02 | N/A | | Power Converter | | | | |
| | Montero | 1983-91 | N/A | | 4 Flat | | | | |
| | Montero | 1992-06 | N/A | | Power Converter | | | | |
| | Montero Sport | 1997-03 | N/A | | Converter | | | | |
| | Montero Sport | 2004-05 | 42365 | 1.5 | Power Converter | | | | |
| | Outlander | 2003-06 | 42345 | 1.5 | Power Converter | | | | |
| | Outlander Sport (with LED taillights) | 2011-15 | 42385 | 1.5 | Power Converter | | | | |
| | Outlander | 2007-12 | 42355 | 1.5 | Power Converter | | | | |
| | Outlander | 2013-16 | 41975 | 1.5 | Power Converter | | | | |
| | Pickup | 1983-96 | N/A | | Converter | | | | |
| Precis | 1987-92 | N/A | | Power Converter | | | | | |
| Raider | 2006-08 | 42205 | 0.5 | 4 Flat | | | | | |
| Raider (with tow package) | 2006-08 | 42145, 42190 | 0.5 | 7 Blade | | | | | |
| NISSAN | 200-SX | 1977-83 | N/A | | Converter | | | | |
| | 200-SX | 1995-98 | N/A | | Converter | | | | |
| | 240-SX | 1989-98 | N/A | | Converter | | | | |
| | 300-ZX | 1984-96 | N/A | | Power Converter | | | | |
| | 310 | 1979-82 | N/A | | Converter | | | | |
| | 370 | 2013-14 | N/A | | Power Converter | | | | |
| | Altima | 1993-96 | N/A | | Converter | | | | |
| | Altima | 1997-01 | 43565 | 1 | Converter | | | | |
| | Altima | 2002-04 | N/A | | Converter | | | | |
| | Altima | 2005-15 | 43675 | 1.5 | Power Converter | | | | |
| | Armada | 2004-15 | 40940, 40950, 40955, 40965, 40975 | 0.5 | 7 Blade | | 47635 | | 50002 |
| | Armada | 2004-15 | 41155 | 0.5 | 4 Flat | | 47635 | | 50002 |
| | Cube | 2009-13 | 43705 | 1.5 | Power Converter | | | | |
| | Frontier Pickup | 1998-03 | 43515 | 0.5 | Converter | | | | |
| | Frontier Pickup | 2004 | 43515 | 0.5 | Converter | | 47635 | | |
| | Frontier Pickup | 2005-06 | 43535 | 1.5 | Power Converter | | 47635 | | |
| | Frontier Pickup (with factory 4 flat) | 2005-11 | 43575 | 0.5 | 4 Flat | | 47635 | | |
| | Frontier Pickup | 2007-15 | 43535 | 1.5 | Power Converter | | 47635 | | |
| | Frontier Pickup (with tow package) | 2011-15 | N/A | | 7 Blade | | 47635 | | |
| | GTR | 2009-10 | N/A | | Power Converter | | | | |
| Juke | 2011-15 | 43685 | 1.5 | Power Converter | | | | | |
| Leaf | 2013 | N/A | | Power Converter | | | | | |
| Maxima | 1981-07 | N/A | | Power Converter | | | | | |





| Make | Model | Year | Plug-In Simple! [®] Vehicle Specific Wiring Kit | Est. Install Time Hours | Universal | 5th Wheel Kits | Brake Control Connectors | Towed Vehicle Kits | Plug-In Simple! [®] Camera |
|------------------------------|-------------------------------|---------|--|----------------------------------|-----------------|----------------------|--------------------------------|--------------------------|---|
| NISSAN | Maxima | 2008-16 | 43675 | 1.5 | Power Converter | | | | |
| | Murano | 2003-05 | 43625 | 1.5 | Power Converter | | | | |
| | Murano | 2006-08 | N/A | | See Dealer | | | | |
| | Murano | 2009-14 | N/A | | Power Converter | | | | |
| | NX 1600/2000 | 1991-93 | N/A | | Converter | | | | |
| | NV Van 1500 / 2500 / 3500 | 2012-16 | 43585 | 1.5 | Power Converter | | 47635 | | |
| | Pathfinder | 1987-95 | N/A | | Converter | | | | |
| | Pathfinder | 1996-03 | 43565 | 0.5 | Converter | | | | |
| | Pathfinder | 2004 | 43565 | 0.5 | Converter | | 47635 | | |
| | Pathfinder (with tow package) | 2005-09 | 43575 | 0.5 | 4 Flat | | 47635 | | |
| | Pathfinder | 2010-12 | N/A | | See Dealer | | 47635 | | |
| | Pathfinder | 2013-15 | 43690 | 1.5 | Power Converter | | 47635 | | |
| | Pathfinder (with tow package) | 2013-15 | 40940, 40950, 40955, 40965, 40975 | 0.5 | 7 Blade | | 47635 | | |
| | Pathfinder (with tow package) | 2013-15 | 41155 | 0.5 | 4 Flat | | 47635 | | |
| | Pickup | 1986-97 | 43505 | 0.5 | Converter | | | | |
| | Pulsar | 1983-90 | N/A | | Converter | | | | |
| | Quest | 2004-09 | 43675 | 1.5 | Power Converter | | | | |
| | Quest | 2010-12 | N/A | | See Dealer | | | | |
| | Rogue | 2008-15 | 43645 | 1.5 | Power Converter | | | | |
| | Sentra | 1982-06 | N/A | | Power Converter | | | | |
| | Sentra | 2007-12 | 43675 | 1.5 | Power Converter | | | | |
| | Sentra | 2013-15 | 43685 | 1.5 | Power Converter | | | | |
| | Stanza | 1982-97 | N/A | | Converter | | | | |
| | Titan | 2004-16 | 40940, 40950, 40955, 40965, 40975 | 0.5 | 7 Blade | 41157 | 47635 | | 50002 |
| | Titan | 2004-16 | 41155 | 0.5 | 4 Flat | 41157 | 47635 | | 50002 |
| | Multi-van | 1987-89 | N/A | | Converter | | | | |
| | Versa | 2007-11 | 43715 | 1.5 | Power Converter | | | | |
| | Versa | 2012-16 | 43704 | 1.5 | Power Converter | | | | |
| | Versa Note | 2014-16 | 43685 | 1.5 | Power Converter | | | | |
| | Xterra | 2000-03 | 43595 | 0.5 | 4 Flat | | | | |
| Xterra | 2004 | 43595 | 0.5 | 4 Flat | | 47635 | | | |
| Xterra | 2005-08 | 43605 | 1.5 | Power Converter | | 47635 | | | |
| Xterra (with factory 4 flat) | 2005-13 | 43575 | 1.5 | 4 Flat | | | | | |
| Xterra (with tow package) | 2005-13 | N/A | | 7 Blade | | 47635 | | | |
| Xterra (with factory 4 flat) | 2014-15 | 43575 | 1.5 | 4 Flat | | | | | |
| Xterra (with tow package) | 2014-15 | N/A | | 7 Blade | | | | | |
| OLDSMOBILE | 88 Series | 1971-79 | N/A | | 4 Flat | | | | |
| | 88 Series | 1980-89 | N/A | | Converter | | | | |
| | 88 Series | 1990-99 | N/A | | 4 Flat | | | | |
| | 98 Series | 1975-96 | N/A | | 4 Flat | | | | |
| | Achieva | 1992-97 | N/A | | 4 Flat | | | | |
| | Alero | 1999-04 | N/A | | Converter | | | | |
| | Aurora | 1995-04 | N/A | | Converter | | | | |
| | Bravada | 1992-94 | N/A | | 4 Flat | | | | |
| | Bravada | 1996-01 | 41225 | 0.5 | 4 Flat | | | | |
| | Bravada | 2002-04 | 40920, 40930, 40940, 40950 40955, 40965, 40975 | 0.5 | 7 Blade | | | | |
| | Bravada | 2002-04 | 41155 | 0.5 | 4 Flat | | | | |
| | Cutlass | 1999 | N/A | | Converter | | | | |
| | Cutlass Calais | 1978-91 | N/A | | 4 Flat | | | | |
| | Cutlass Ciera | 1982-96 | N/A | | 4 Flat | | | | |
| | Cutlass Sedan | 1974-97 | N/A | | 4 Flat | | | | |
| | Cutlass Supreme | 1975-97 | N/A | | 4 Flat | | | | |
| | Custom Cruiser | 1991-92 | 41195 | 0.5 | 4 Flat | | | | |
| | Firenza | 1983-88 | N/A | | 4 Flat | | | | |
| | Intrigue | 1998-02 | N/A | | Converter | | | | |
| | LSS | 1996-97 | N/A | | Power Converter | | | | |
| | Omega | 1974-84 | N/A | | 4 Flat | | | | |
| | Regency | 1997-98 | N/A | | 4 Flat | | | | |
| | Silhouette | 1990-92 | N/A | | 4 Flat | | | | |
| | Silhouette | 1993-96 | 41355 | 0.5 | 4 Flat | | | | |
| | Silhouette | 1997-05 | 41365 | 0.5 | Converter | | | | |
| | Starfire | 1975-80 | N/A | | 4 Flat | | | | |
| | Toronado | 1979-85 | N/A | | 4 Flat | | | | |
| Toronado | 1986-92 | N/A | | Power Converter | | | | | |

| Make | Model | Year | Plug-In Simple! [®] Vehicle Specific Wiring Kit | Est. Install Time Hours | Universal | 5th Wheel Kits | Brake Control Connectors | Towed Vehicle Kits | Plug-In Simple! [®] Camera |
|-------------------------|----------------------|---------|--|----------------------------------|-----------------|----------------------|--------------------------------|--------------------------|---|
| PLYMOUTH | Acclaim | 1989-95 | N/A | | Power Converter | | | | |
| | Arrow | 1976-80 | N/A | | Converter | | | | |
| | Breeze | 1996-00 | N/A | | Converter | | | | |
| | Caravelle | 1985-88 | N/A | | 4 Flat | | | | |
| | Colt | 1983-94 | N/A | | Converter | | | | |
| | Colt Vista | 1984-94 | N/A | | Converter | | | | |
| | Duster | 1985-94 | N/A | | Converter | | | | |
| | Grand Fury | 1975-89 | N/A | | 4 Flat | | | | |
| | Horizon | 1978-90 | N/A | | Converter | | | | |
| | Laser | 1990-94 | N/A | | 4 Flat | | | | |
| | Neon | 1995-01 | N/A | | 4 Flat | | | | |
| | Prowler | 1996-01 | N/A | | Power Converter | | | | |
| | Reliant | 1981-89 | N/A | | 4 Flat | | | | |
| | Sundance | 1987-94 | N/A | | 4 Flat | | | | |
| | Turismo | 1982-87 | N/A | | 4 Flat | | | | |
| | Van (full size) | 1974-83 | N/A | | Converter | | | | |
| | Volare | 1976-80 | N/A | | 4 Flat | | | | |
| Voyager / Grand Voyager | 1984-90 | N/A | | 4 Flat | | | | | |
| Voyager / Grand Voyager | 1991-95 | 42205 | 1 | 4 Flat | | | | | |
| Voyager / Grand Voyager | 1996-00 | 42215 | 1 | Converter | | | | | |
| Voyager / Grand Voyager | 2001-03 | 42225 | 1 | Converter | | | | | |
| PONTIAC | 6000 | 1982-91 | N/A | | Power Converter | | | | |
| | Astre | 1975-77 | N/A | | 4 Flat | | | | |
| | Aztek | 2001-05 | 41405 | 1 | 4 Flat | | | | |
| | Bonneville | 1975-86 | N/A | | 4 Flat | | | | |
| | Bonneville | 1987-05 | N/A | | Power Converter | | | | |
| | Catalina / Gr. Ville | 1975-81 | N/A | | 4 Flat | | | | |
| | Firebird | 1975-88 | N/A | | 4 Flat | | | | |
| | Firebird | 1989-02 | N/A | | Power Converter | | | | |
| | G5 (2 door) | 2007-10 | 41555 | 1 | 4 Flat | | | 56100 | |
| | G5 GT (2 door) | 2007-10 | 41555 | 1 | 4 Flat | | | 56100 | |
| | G5 (4 door) | 2007-09 | 41565 | 1 | 4 Flat | | | | |
| | G6 | 2005-09 | 41605 | 1.5 | Power Converter | | | | |
| | Grand Am | 1974-88 | N/A | | 4 Flat | | | | |
| | Grand Am | 1989-91 | N/A | | Converter | | | | |
| | Grand Am | 1992-95 | N/A | | 4 Flat | | | | |
| | Grand Am | 1996-05 | N/A | | Converter | | | | |
| | Grand Lemans | 1975-81 | N/A | | 4 Flat | | | | |
| | Grand Prix | 1974-87 | N/A | | 4 Flat | | | | |
| | Grand Prix | 1988-08 | N/A | | Power Converter | | | | |
| | GTO | 2004-06 | N/A | | Converter | | | | |
| | J2000 | 1982-84 | N/A | | 4 Flat | | | | |
| | Lemans | 1975-77 | N/A | | 4 Flat | | | | |
| | Lemans | 1978-81 | N/A | | Converter | | | | |
| | Lemans | 1982-93 | N/A | | 4 Flat | | | | |
| | Montana | 1997-06 | 41365 | 1 | Converter | | | | |
| | Montana SV6 | 2005-06 | 41175 | 1 | 4 Flat | | | | |
| | Parisienne | 1983-86 | N/A | | 4 Flat | | | | |
| | Persuit (2 door) | 2005-10 | 41555 | 1 | 4 Flat | | | 56100 | |
| | Persuit (4 door) | 2005-10 | 41565 | 1 | 4 Flat | | | | |
| | Phoenix | 1980-84 | N/A | | 4 Flat | | | | |
| | Solstice | 2007-09 | N/A | | 4 Flat | | | | |
| | Sunbird | 1976-84 | N/A | | Converter | | | | |
| | Sunbird | 1985-87 | N/A | | 4 Flat | | | | |
| | Sunbird | 1988-94 | N/A | | Converter | | | | |
| Sunfire | 1995-05 | N/A | | 4 Flat | | | | | |
| Torrent | 2006 | 41235 | 1.5 | Power Converter | | | | | |
| Torrent | 2007-09 | 41265 | 1 | 4 Flat | | | | | |
| Trans Sport Van | 1990-92 | N/A | | 4 Flat | | | | | |
| Trans Sport Van | 1993-96 | 41355 | 1 | 4 Flat | | | | | |
| Trans Sport Van | 1997-04 | 41365 | 1 | Converter | | | | | |
| Ventura | 1971-77 | N/A | | 4 Flat | | | | | |
| Vibe | 2003-08 | 41425 | 1.5 | Power Converter | | | | | |
| Vibe | 2009-12 | 43345 | 1.5 | Power Converter | | | | | |

| Make | Model | Year | Plug-In Simple! [®] Vehicle Specific Wiring Kit | Est. Install Time Hours | Universal | 5th Wheel Kits | Brake Control Connectors | Towed Vehicle Kits | Plug-In Simple! [®] Camera |
|---|---|--------------|--|----------------------------------|-----------------|----------------------|--------------------------------|--------------------------|---|
| PORSCHE | Boxster | 2001-07 | N/A | | See Dealer | | | | |
| | Boxster | 2009-10 | N/A | | See Dealer | | | | |
| | Carrera | 2005 | N/A | | See Dealer | | | | |
| | Cayman | 2006 | N/A | | See Dealer | | | | |
| | Cayman | 2009-10 | N/A | | See Dealer | | | | |
| | Cayenne | 2003-06 | N/A | | Power Converter | | | | |
| | Cayenne | 2008-10 | N/A | | Power Converter | | | | |
| | Cayenne (with tow package) | 2013-14 | 40940, 40950, 40955, 40965, 40975 | 0.5 | 7 Blade | | | | |
| Cayenne (with tow package) | 2013-14 | 41155 | 0.5 | 4 Flat | | | | | |
| RAM <small>(SEE DODGE FOR 2009 OR OLDER RAMS)</small> | Ram 1500 (with tow package) | 2010-12 | 40940, 40950, 40955, 40965, 40974, 40975 | 0.5 | 7 Blade | 41157 | 53015 | | 50002 |
| | Ram 1500 (with tow package) | 2010-12 | 41155 | 0.5 | 4 Flat | 41157 | 53015 | | 50002 |
| | Ram 1500 (with tow package) | 2013-14 | 40940, 40950, 40955, 40965, 40974, 40975 | 0.5 | 7 Blade | 41157 | 53055 | | 50002 |
| | Ram 1500 (with tow package) | 2013-14 | 41155 | 0.5 | 4 Flat | 41157 | 53055 | | 50002 |
| | Ram 1500 (with tow package) | 2015-16 | 40940, 40950, 40955, 40965, 40974, 40975 | 0.5 | 7 Blade | 41157 | 53065 | | 50002 |
| | Ram 1500 (with tow package) | 2015-16 | 41155 | 0.5 | 4 Flat | 41157 | 53065 | | 50002 |
| | Ram Pickup 2500/3500 (with tow package) | 2010-12 | 40940, 40950, 40955, 40965, 40974, 40975 | 0.5 | 7 Blade | 41157 | 53015 | | 50002 |
| | Ram Pickup 2500/3500 (with tow package) | 2010-12 | 41155 | 0.5 | 4 Flat | 41157 | 53015 | | 50002 |
| | Ram Pickup 2500/3500 (with tow package) | 2013-14 | 40940, 40950, 40955, 40965, 40974, 40975 | 0.5 | 7 Blade | 41157 | 53055 | | 50002 |
| | Ram Pickup 2500/3500 (with tow package) | 2013-14 | 41155 | 0.5 | 4 Flat | 41157 | 53055 | | 50002 |
| | Ram Pickup 2500/3500 (with tow package) | 2015-16 | 40940, 40950, 40955, 40965, 40974, 40975 | 0.5 | 7 Blade | 41157 | 53056 | | 50002 |
| | Ram Pickup 2500/3500 (with tow package) | 2015-16 | 41155 | 0.5 | 4 Flat | 41157 | 53056 | | 50002 |
| | Ram Promaster | 2014-15 | 42304 | 1.5 | Power Converter | | | | |
| | Ram Promaster (with tow package) | 2014-15 | 40940, 40950, 40955, 40965, 40975 | 0.5 | 7 Blade | | | | |
| | Ram Promaster (with tow package) | 2014-15 | 41155 | 0.5 | 4 Flat | | | | |
| Ram Tradesman Van (with tow package) | 2014-15 | 42145, 42190 | 0.5 | 7 Blade | | | | | |
| RENAULT | 18i | 1980-86 | N/A | | Converter | | | | |
| | Alliance | 1983-87 | N/A | | Converter | | | | |
| | Fuego | 1982-85 | N/A | | Converter | | | | |
| | Medallion | 1988-89 | N/A | | Power Converter | | | | |
| | Sportwagon | 1984-85 | N/A | | Converter | | | | |
| SAAB | 9-2X | 2005 | N/A | | Power Converter | | | | |
| | 9-3 | 2003 | N/A | | Power Converter | | | | |
| | 9-3X | 2007-09 | N/A | | Power Converter | | | | |
| | 9-5 Aero | 2004-06 | N/A | | Power Converter | | | | |
| | 9-7X | 2005-10 | 40920, 40930, 40940, 40950 40955, 40965, 40975 | 0.5 | 7 Blade | | | | |
| | 9-7X | 2005-10 | 41155 | 0.5 | 4 Flat | | | | |
| SATURN | Astra | 2008-09 | N/A | | Power Converter | | | | |
| | Aura | 2007-09 | 41705 | 1.5 | Power Converter | | | | |
| | Ion | 2003-07 | N/A | | Power Converter | | | | |
| | L Series | 2000-04 | N/A | | Power Converter | | | | |
| | LS | 2004-05 | N/A | | Power Converter | | | | |
| | LW 200 | 2001-05 | N/A | | Power Converter | | | | |
| | Outlook (with tow package) | 2007-10 | 40920, 40930, 40940, 40950 40955, 40965, 40975 | 0.5 | 7 Blade | | 47875 | 56301 | |
| | Outlook (with tow package) | 2007-10 | 41155 | 0.5 | 4 Flat | | 47875 | 56301 | |
| | Outlook | 2007-10 | 41725 | 1 | 4 Flat | | 47875 | 56301 | |
| | Relay | 2005-07 | 41175 | 1 | 4 Flat | | | | |
| | S Series | 1991-02 | N/A | | Converter | | | | |
| | Sky | 2007-09 | N/A | | Power Converter | | | | |
| VUE | 2002-07 | 40935 | 1.5 | Power Converter | | | | | |
| VUE | 2008-10 | 41745 | 1.5 | Power Converter | | | 56303 | | |

| Make | Model | Year | Plug-In Simple! [®] Vehicle Specific Wiring Kit | Est. Install Time Hours | Universal | 5th Wheel Kits | Brake Control Connectors | Towed Vehicle Kits | Plug-In Simple! [®] Camera |
|---------------|-------------------------------|---------|--|----------------------------------|-----------------|----------------------|--------------------------------|--------------------------|---|
| SCION | Scion FR-S | 2013-16 | 41974 | 1.5 | Power Converter | | | | |
| | Scion IQ (Late 2012) | 2012-14 | N/A | | Power Converter | | | | |
| | Scion TC | 2007-10 | 41975 | 1.5 | Power Converter | | | | |
| | Scion TC | 2011-16 | 41964 | 1.5 | Power Converter | | | | |
| | Scion XA | 2004-05 | 41954 | 1.5 | Converter | | | | |
| | Scion XB | 2004-07 | 41955 | 1.5 | Power Converter | | | | |
| | Scion XB | 2008-10 | 41965 | 1.5 | Power Converter | | | | |
| | Scion XB | 2011-12 | 43345 | 1.5 | Power Converter | | | | |
| Scion XD | 2008-14 | 41985 | 1.5 | Power Converter | | | | | |
| SUBARU | B9 Tribeca | 2006-16 | 43855 | 1.5 | Power Converter | | | | |
| | Baja | 2002-06 | 43875 | 1.5 | Power Converter | | | | |
| | Brat | 1978-87 | N/A | | Converter | | | | |
| | BRZ | 2013-15 | 41974 | 1.5 | Power Converter | | | | |
| | Forester | 1998-08 | 43855 | 1.5 | Power Converter | | | | |
| | Forester | 2009-16 | 43865 | 1.5 | Power Converter | | | | |
| | GL | 1980-86 | N/A | | Converter | | | | |
| | GL | 1987-92 | N/A | | Power Converter | | | | |
| | Impreza (Sedan) | 1993-01 | N/A | | Power Converter | | | | |
| | Impreza (Sedan) | 2002-07 | 43855 | 1.5 | Power Converter | | | | |
| | Impreza (Sedan) | 2008-16 | 43884 | 1.5 | Power Converter | | | | |
| | Impreza Hatchback | 2008-13 | 43894 | 1.5 | Power Converter | | | | |
| | Impreza WRX | 2008-16 | 43865 | 1.5 | Power Converter | | | | |
| | Justy | 1989-93 | N/A | | Power Converter | | | | |
| | Legacy (Sedan & Wagon) | 1990-07 | N/A | | Power Converter | | | | |
| | Legacy | 1996-02 | N/A | | Power Converter | | | | |
| | Legacy | 2003-08 | 43855 | 1.5 | Power Converter | | | | |
| | Legacy | 2011-16 | 43624 | 1.5 | Power Converter | | | | |
| | Loyale | 1990-93 | N/A | | Power Converter | | | | |
| | Outback | 1996-08 | 43855 | 1.5 | Power Converter | | | | |
| Outback Wagon | 2010-14 | 43865 | 1.5 | Power Converter | | | | | |
| Outback | 2015-16 | 43885 | 1.5 | Power Converter | | | | | |
| SVX | 1992-96 | N/A | | Power Converter | | | | | |
| XV Crosstrek | 2013-16 | 43865 | 1.5 | Power Converter | | | | | |
| SUZUKI | Aerio | 2003-06 | N/A | | Power Converter | | | | |
| | Equator | 2009-12 | 43535 | 1.5 | Power Converter | | | | |
| | Equator (with factory 4 flat) | 2009-12 | 43575 | 0.5 | 4 Flat | | | | |
| | Esteem | 1995-01 | N/A | | Converter | | | | |
| | Forenza | 2004-08 | N/A | | Power Converter | | | | |
| | Kizashi | 2010-11 | 41254 | 1.5 | Power Converter | | | | |
| | Vitara / Grand Vitara | 1999-05 | 41245 | 1 | Converter | | | | |
| | Vitara / Grand Vitara | 2006-12 | 41255 | 1 | Converter | | | | |
| | Reno | 2006-08 | N/A | | Power Converter | | | | |
| | Samari | 1986-94 | N/A | | Converter | | | | |
| | Sidekick | 1989-98 | N/A | | Converter | | | | |
| | Swift | 1989-01 | N/A | | Converter | | | | |
| | SX4 | 2007-11 | 41255 | 1.5 | Power Converter | | | | |
| | SX4 Sport | 2008-09 | 43574 | 1.5 | Power Converter | | | | |
| | Verona | 2004-06 | N/A | | Power Converter | | | | |
| | XL-7 | 2001-05 | 41245 | 1 | Converter | | | | |
| | XL-7 | 2006-08 | N/A | | Power Converter | | | | |
| X-90 | 1996-98 | N/A | | Converter | | | | | |
| TOYOTA | Avalon | 1995-09 | N/A | | Converter | | | | |
| | Avalon | 2011-12 | 41795 | 1.5 | Power Converter | | | | |
| | Avalon | 2013-15 | 41820 | 1.5 | Power Converter | | | | |
| | Camry | 1983-86 | N/A | | Converter | | | | |
| | Camry | 1987-91 | N/A | | Power Converter | | | | |
| | Camry | 1992-96 | N/A | | Converter | | | | |
| | Camry | 1997-01 | 41765 | 1 | Converter | | | | |
| | Camry | 2002-06 | 41775 | 1.5 | Power Converter | | | | |
| | Camry | 2007-09 | 41824 | 1.5 | Power Converter | | | | |
| | Camry (Hybrid) | 2007-09 | 41795 | 1.5 | Power Converter | | | | |
| | Camry | 2010-11 | 41795 | 1.5 | Power Converter | | | | |
| | Camry, Camry Hybrid | 2012-16 | 41824 | 1.5 | Power Converter | | | | |
| | Celica | 1975-03 | N/A | | Converter | | | | |
| | Corolla | 1976-08 | N/A | | Converter | | | | |
| | Corolla | 2009-13 | 41815 | 1.5 | Power Converter | | | | |
| Corolla | 2014-16 | 41824 | 1.5 | Power Converter | | | | | |





| Make | Model | Year | Plug-In Simple! [®] Vehicle Specific Wiring Kit | Est. Install Time Hours | Universal | 5th Wheel Kits | Brake Control Connectors | Towed Vehicle Kits | Plug-In Simple! [®] Camera |
|-------------------------------|-------------------------------------|---------|--|----------------------------------|-----------------|----------------------|--------------------------------|--------------------------|---|
| TOYOTA | Cressida | 1981-93 | N/A | | Converter | | | | |
| | ECHO | 2000-02 | 43335 | 1.5 | Power Converter | | | | |
| | FJ Cruiser | 2007-14 | 41824 | 1.5 | Power Converter | | | | |
| | Highlander (with factory 4 flat) | 2001-03 | 41875 | 0.5 | 4 Flat | | | | |
| | Highlander (without tow package) | 2001-06 | 43425 | 1.5 | Power Converter | | | | |
| | Highlander (without LED taillights) | 2007 | 43425 | 1.5 | Power Converter | | | | |
| | Highlander (Hybrid) | 2006-10 | N/A | | Power Converter | | | | |
| | Highlander (with tow package) | 2008-15 | 41825 | 0.5 | 4 Flat | | | | |
| | Highlander (without tow package) | 2008-15 | 41845 | 1.5 | Power Converter | | | | |
| | Land Cruiser | 1981-90 | N/A | | Power Converter | | | | |
| | Land Cruiser | 1991-99 | 43405 | 0.5 | Converter | | | | |
| | Land Cruiser | 2000-02 | N/A | | Power Converter | | | | |
| | Land Cruiser | 2003-11 | N/A | | Power Converter | | 47815 | | |
| | Land Cruiser | 2012 | N/A | | Power Converter | | | | |
| | Land Cruiser | 2013 | N/A | | Power Converter | | 47815 | | |
| | Matrix | 2003-08 | 43335 | 1.5 | Power Converter | | | | |
| | Matrix | 2009-12 | 43345 | 1.5 | Power Converter | | | | |
| | MR2 | 1985-95 | N/A | | Converter | | | | |
| | Paseo | 1992-98 | N/A | | Converter | | | | |
| | Pickup (except T-100) | 1975-83 | N/A | | Converter | | | | |
| | Pickup (except T-100) | 1984-95 | 43315 | 0.5 | Converter | | | | |
| | Previa Van | 1991-97 | N/A | | Converter | | | | |
| | Prius | 2001-03 | N/A | | Power Converter | | | | |
| | Prius | 2004-15 | 41854 | 1.5 | Power Converter | | | | |
| | Prius C | 2012-16 | 41955 | 1.5 | Power Converter | | | | |
| | Prius V | 2012-16 | 43314 | 1.5 | Power Converter | | | | |
| | RAV 4 | 1996-00 | 43455 | 1 | Converter | | | | |
| | RAV 4 | 2001-05 | 43465 | 1 | Converter | | | | |
| | RAV 4 | 2006-12 | 43445 | 1.5 | Power Converter | | | | |
| | RAV 4 | 2013-15 | 41820 | 1.5 | Power Converter | | | | |
| | 4-Runner | 1987-95 | N/A | | Converter | | | | |
| | 4-Runner | 1996-02 | 43415 | 1 | Converter | | | | |
| | 4-Runner | 2003-09 | N/A | | Converter | | 47815 | | |
| | 4-Runner (with tow package) | 2003-09 | 43374 | 0.5 | 7 Blade | | 47815 | | |
| | 4-Runner (with tow package) | 2010-13 | 41855 | 0.5 | Converter | | 47815 | | |
| | 4-Runner (with tow package) | 2014 | 41855 | 0.5 | Converter | | | | |
| | Sequoia | 2001 | 43435 | 1 | 4 Flat | | | | |
| | Sequoia | 2002 | 43435 | 1 | 4 Flat | | 47815 | | |
| | Sequoia (with tow package) | 2003-04 | 43384 | 0.5 | 7 Blade | | 47815 | | |
| | Sequoia (with tow package) | 2005-09 | 43325 | 0.5 | Converter | | 47815 | | |
| | Sequoia (with tow package) | 2010-12 | 40940, 40950, 40955, 40965, 40975 | 0.5 | Power Converter | | 47815 | | |
| | Sequoia (with tow package) | 2010-12 | 41155 | 0.5 | Power Converter | | 47815 | | |
| | Sequoia (with tow package) | 2013-14 | 40940, 40950, 40955, 40965, 40975 | 0.5 | Power Converter | | | | |
| | Sequoia (with tow package) | 2013-14 | 41155 | 0.5 | Power Converter | | | | |
| | Sienna | 1998-03 | 43475 | 1 | Converter | | | | |
| | Sienna | 2004-10 | 43485 | 1.5 | Power Converter | | | | |
| | Sienna SE | 2011-15 | 43495 | 1.5 | Power Converter | | | | |
| Starlet | 1981-84 | N/A | | Converter | | | | | |
| Solara | 1999-06 | N/A | | Converter | | | | | |
| Solara | 2007-08 | N/A | | Power Converter | | | | | |
| Supra | 1982-98 | N/A | | Power Converter | | | | | |
| Tacoma | 1995-04 | 43315 | 0.5 | Converter | | | | | |
| Tacoma (without tow package) | 2005-08 | 43355 | 0.5 | Converter | | 47815 | | | |
| Tacoma (without tow package) | 2009-13 | N/A | | Converter | | 47815 | | | |
| Tacoma (with tow package) | 2005-13 | N/A | | Converter | | 47815 | | | |
| Tacoma (without tow package) | 2014-15 | 43355 | 0.5 | Converter | | | | | |
| Tacoma (with tow package) | 2014-15 | N/A | | Converter | | | | | |
| Tercel | 1980-98 | N/A | | Converter | | | | | |
| T-100 | 1993-98 | 43355 | 0.5 | Converter | | | | | |
| Tundra | 2000 | 43365 | 0.5 | Converter | | | | | |
| Tundra | 2001-02 | 43375 | 1.5 | Power Converter | | | | | |
| Tundra (with tow package) | 2003-06 | 43385 | 0.5 | Converter | | 47815 | | | |
| Tundra (with factory 7 blade) | 2007-12 | 43395 | 0.5 | 7 Blade | 43397 | 47815 | | | |
| Tundra (with factory 4 flat) | 2010-12 | 41835 | 1.5 | Power Converter | | 47815 | | | |
| Tundra (with factory 7 blade) | 2013 | 43395 | 0.5 | 7 Blade | 43397 | | | | |

| Make | Model | Year | Plug-In Simple! [®] Vehicle Specific Wiring Kit | Est. Install Time Hours | Universal | 5th Wheel Kits | Brake Control Connectors | Towed Vehicle Kits | Plug-In Simple! [®] Camera |
|----------------------------|-------------------------------|---------|--|----------------------------------|-----------------|----------------------|--------------------------------|--------------------------|---|
| TOYOTA | Tundra (with factory 4 flat) | 2013-15 | 41835 | 1.5 | Power Converter | | | | |
| | Tundra (with factory 7 blade) | 2014-15 | 40940, 40950, 40955, 40965, 40975 | 0.5 | 7 Blade | 41157 | | | 50002 |
| | Tundra (with factory 7 blade) | 2014-15 | 41155 | 0.5 | 4 Flat | 41157 | | | 50002 |
| | Vanwagon | 1984-90 | N/A | | Converter | | | | |
| | Venza | 2009-15 | 41795 | 1.5 | Power Converter | | | | |
| | Yaris | 2007-09 | N/A | | | | | | |
| | Yaris | 2010-15 | 41844 | 1.5 | Power Converter | | | | |
| VOLKSWAGEN | Beetle | 1974-79 | N/A | | Converter | | | | |
| | Beetle | 1998-11 | N/A | | Power Converter | | | | |
| | Beetle | 2012-15 | N/A | | Power Converter | | | | |
| | Cabrio | 1985-05 | N/A | | Converter | | | | |
| | CC | 2012-14 | N/A | | See Dealer | | | | |
| | Corrado | 1989-94 | N/A | | Converter | | | | |
| | EOS | 2007-10 | N/A | | Power Converter | | | | |
| | EOS | 2012-15 | N/A | | See Dealer | | | | |
| | Eurovan | 1983-00 | N/A | | Converter | | | | |
| | Fox | 1987-93 | N/A | | Converter | | | | |
| | Golf | 1985-06 | N/A | | Converter | | | | |
| | Golf | 2013-15 | N/A | | See Dealer | | | | |
| | GTI (early 2006) | 1985-06 | N/A | | Converter | | | | |
| | GTI (Late 2006) | 2006-09 | N/A | | See Dealer | | | | |
| | GTI | 2010-15 | N/A | | See Dealer | | | | |
| | Jetta | 1980-05 | N/A | | Converter | | | | |
| | Jetta | 2006-09 | N/A | | Power Converter | | | | |
| | Jetta | 2011-14 | N/A | | Power Converter | | | | |
| | Passat | 1990-09 | N/A | | Power Converter | | | | |
| | Passat Sedan | 2012-15 | N/A | | PWM | | | | |
| | Passat Wagon | 2012-15 | N/A | | PWM | | | | |
| | Quantum | 1982-88 | N/A | | Converter | | | | |
| | R32 | 2008 | N/A | | Power Converter | | | | |
| | Rabbit | 1975-84 | N/A | | Converter | | | | |
| | Routan | 2009 | N/A | | 4 Flat | | | | |
| | Routan | 2011-13 | 43764 | 1.5 | Power Converter | | | | |
| | Scirocco | 1975-88 | N/A | | Converter | | | | |
| | Tiguan | 2009-10 | N/A | | Power Converter | | | | |
| | Touareg | 2004-10 | N/A | | See Dealer | | | | |
| | Touareg (without tow package) | 2012-15 | N/A | | See Dealer | | | | |
| | Touareg (with tow package) | 2012-15 | 40940, 40950, 40955, 40965, 40975 | 0.5 | 7 Blade | | | | |
| Touareg (with tow package) | 2012-15 | 41155 | 0.5 | 4 Flat | | | | | |
| Vanagon | 1980-92 | N/A | | Converter | | | | | |
| VOLVO | 40 | 2004-09 | N/A | | Power Converter | | | | |
| | 50 | 2005-06 | N/A | | Power Converter | | | | |
| | 60 | 2006-09 | N/A | | Power Converter | | | | |
| | 70 | 2006-08 | N/A | | Power Converter | | | | |
| | 80 | 2004-09 | N/A | | Power Converter | | | | |
| | C-30 | 2008-13 | N/A | | Power Converter | | | | |
| | C-70 | 2011-14 | 43724 | 1.5 | Power Converter | | | | |
| | S-40 | 2002-05 | N/A | | Power Converter | | | | |
| | S-40 | 2008-09 | N/A | | Power Converter | | | | |
| | S-60 | 2008-09 | N/A | | Power Converter | | | | |
| | S-60 | 2013-16 | 43720 | 1.5 | Power Converter | | | | |
| | S-80 | 2002-06 | N/A | | Power Converter | | | | |
| | S-80 | 2007-15 | 43725 | 1.5 | Power Converter | | | | |
| | V-60 | 2015-16 | N/A | | Power Converter | | | | |
| | V-70 | 2006-07 | N/A | | Power Converter | | | | |
| | V-70 | 2008-11 | 43735 | 1.5 | Power Converter | | | | |
| | V-70 XC AWD | 2002 | N/A | | Power Converter | | | | |
| | V-70R | 2004-06 | N/A | | Power Converter | | | | |
| | XC-60 | 2010-16 | 43744 | 1.5 | Power Converter | | | | |
| | XC-70 | 2008-16 | 43735 | 1.5 | Power Converter | | | | |
| | XC-70 AWD | 2002-04 | N/A | | Power Converter | | | | |
| | XC-90 | 2003-04 | N/A | | Power Converter | | | | |
| | XC-90 | 2005-14 | 43745 | 1.5 | Power Converter | | | | |
| XC-90 | 2015-16 | 43744 | 1.5 | Power Converter | | | | | |

VEHICLE AND TRAILER WIRING CODES

IMPORTANT - Identify the wires on your vehicle and trailer by function only. Color coding is not standard among all manufacturers. Illustrations represent the rear views of the connectors.

VEHICLE SIDE

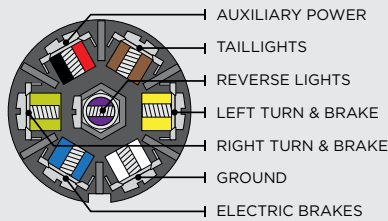

7 BLADE (SAE STANDARD)

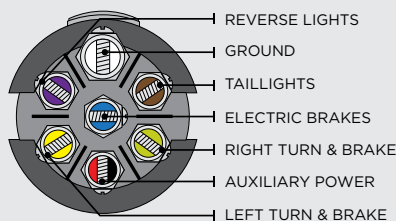

7 ROUND

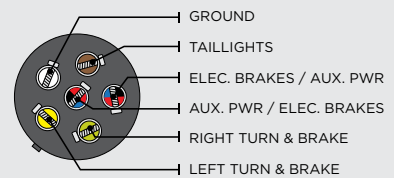

6 ROUND

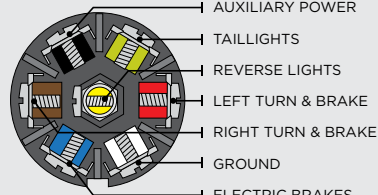

7 BLADE (RV STANDARD)

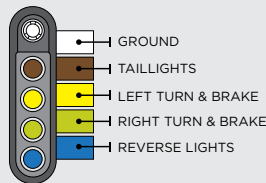

5 FLAT

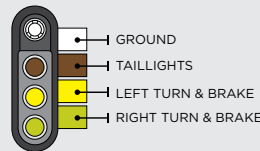

4 FLAT

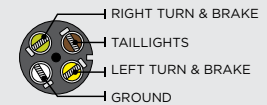

4 ROUND

TRAILER SIDE

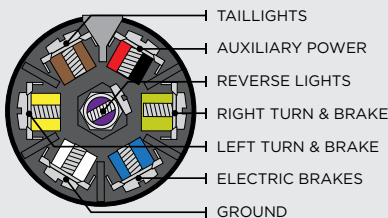

7 BLADE

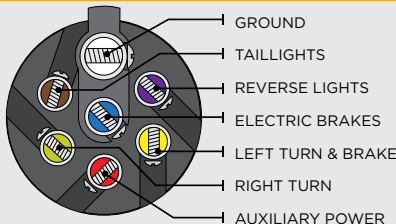

7 ROUND

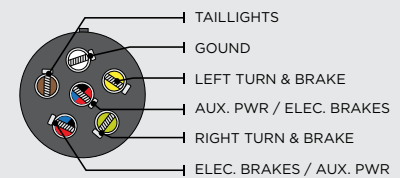

6 ROUND

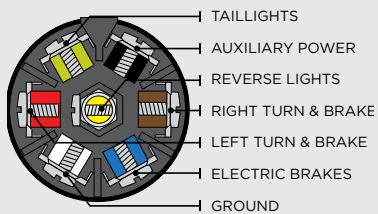

7 BLADE (RV STANDARD)

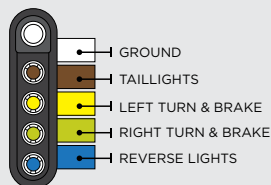

5 FLAT

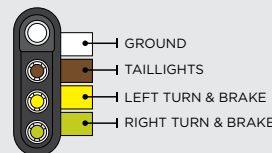

4 FLAT

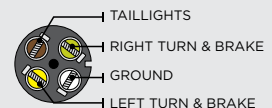

4 ROUND

4 FLAT Y-HARNESS WIRING DIAGRAM

FOR PART 48240, 48245
NUMBERS 48255, 48265

Time to wire up or rewire your trailer? A Y-Harness provides all the wire needed to get to every light on your trailer.

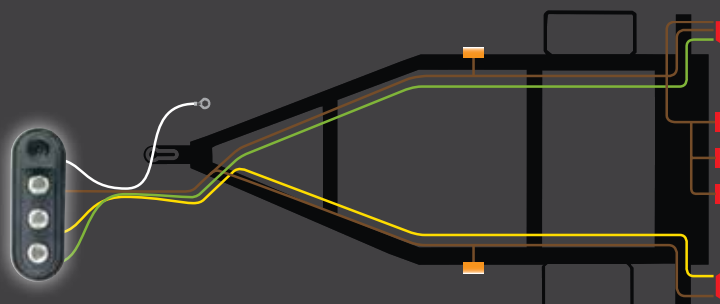

BRAKE CONTROL INFORMATION

CROSS-REFERENCE BRAKE CONTROL WIRING GUIDE

| WIRE FUNCTIONS | | 12 VOLTS | STOPLIGHT | GROUND | TRAILER BRAKES | ILLUMINATION | | | |
|--------------------------|----------------------------------|---------------------------|------------|-------------|----------------|--------------|-----------|------------|----------|
| BRAKE CONTROL WIRE COLOR | | BLACK | RED | WHITE | BLUE | NOT USED | | | |
| MAKE | MODEL - YEAR | VEHICLE O.E.M. WIRE COLOR | | | | | | | |
| CHEVY / GMC | 2007 (New Body Style) - 2013 | RED | LT BLUE | WHITE | WHITE | DARK BLUE | BROWN | | |
| CHEVY / GMC | 1999 - 2007 (Classic Body Style) | RED | LIGHT BLUE | | BLACK | DARK BLUE | BROWN | | |
| GMC | Pickups 2014-15 | RED | YELLOW | BLUE | WHITE | BLACK | BLUE | NOT USED | |
| GMC | SUV Tahoe / Suburban | PINK | | BLUE | WHITE | BLACK | BLUE | NOT USED | |
| DODGE | 2009-2012 | RED | YELLOW | WHITE | VIOLET | BLACK | DRK GREEN | DARK GREEN | NOT USED |
| DODGE | 2003-2008 | RED | WHITE | BLUE | WHITE | BLACK | GREEN | BLUE | NOT USED |
| DODGE | 1997-2002 | RED | | WHITE | | BLACK | BLUE | NOT USED | |
| FORD | F-250 / 350 2009-2015 | RED | BROWN | BLUE | ORANGE | BLACK | GRAY | BLUE | NOT USED |
| FORD | F-150 2009-2015 | RED or RED | GRAY | GREEN | or YEL GRN | WHITE | BROWN | BLUE | NOT USED |
| FORD | F-150 1994-2008 | RED | | LIGHT GREEN | | WHITE | BLUE | DARK BLUE | BROWN |
| TOYOTA / LEXUS | 2003-2012 | BLACK | GREEN | YELLOW | BLACK | WHITE | BLUE | RED | GREEN |

TM

TRAILER WEIGHT LIMIT INFORMATION

BE SAFE, BE LEGAL.

Whether you live in or are traveling through, a braking system is required in most states and provinces, if your trailer weight exceeds the limit*

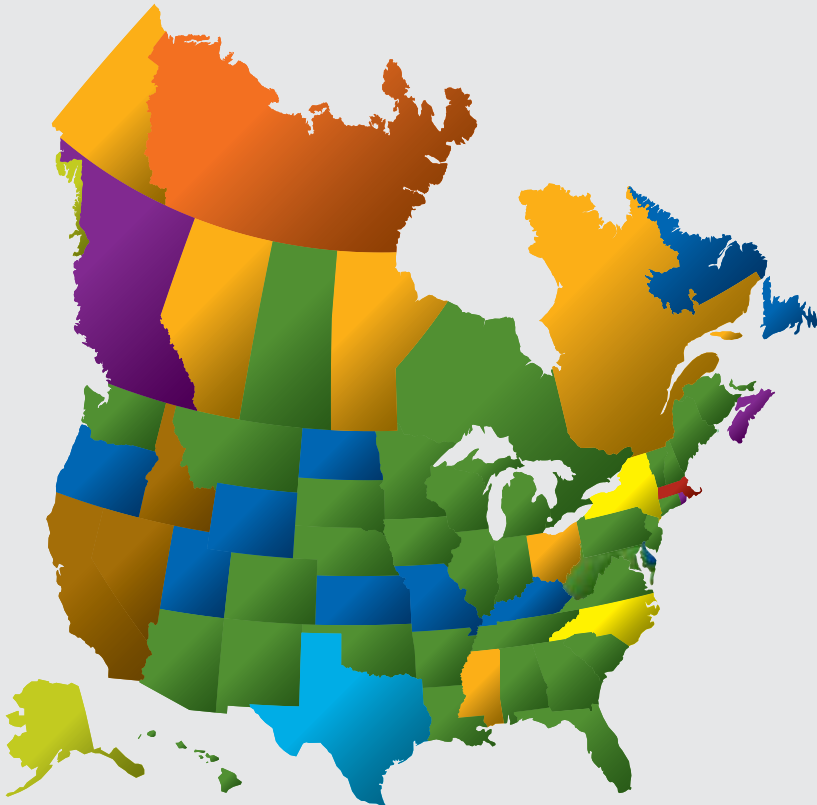

WEIGHT LIMIT

- 0 lb.
- 1,000 lb (455 kg)
- 1,500 lb (682kg)
- 2,000 lb (910 kg)
- 3,000 lb (1360 kg)
- 4,000 lb (1800 kg)
- 4,500 lb (2045 kg)
- 5,000 lb (2273 kg)
- 10,000 lb (4545 kg)
- Special requirements

*Contact your department of transportation for complete towing law information

BRAKE CONTROL INFORMATION

TM

EVERYTHING TO GET STARTED

Hopkins® starter kits contain a wide range of top-selling products covering basic wiring to premium and innovative solutions. Each kit comes with an easy-to-follow product selection header and consumer help guide that will assist in consumer purchasing decisions and increase satisfaction.



HOPKINS STEPS TO WIRING SUCCESS

1 DETERMINE YOUR WIRING NEEDS

- Color Coded For Quick Selection
- VEHICLE SIDE
- ADAPTERS
- TRAILER SIDE
- BRAKE CONTROLS
- ACCESSORIES

2 IDENTIFY YOUR CONNECTORS

VEHICLE SIDE

- 7 RV Blade
- 7 Pole Round
- 6 Pole Round
- 6 Pole Square
- 5 Wire Flat
- 4 Wire Flat
- 4 Pole Round

TRAILER SIDE

3 CHOOSE YOUR PRODUCT

GOOD BETTER BEST

Provides Basic Towing Solutions

Provides Unique, Innovative Towing Solutions

Loaded With Performance Enhancements, ENDURANCE™ Products Set The New Standard For Quality

27627 - SMALL STARTER ASSORTMENT (25 SKUs)

HOPKINS STEPS TO WIRING SUCCESS

1 DETERMINE YOUR WIRING NEEDS

- Color Coded For Quick Selection
- VEHICLE SIDE
- ADAPTERS
- TRAILER SIDE
- BRAKE CONTROLS
- ACCESSORIES

2 IDENTIFY YOUR CONNECTORS

VEHICLE SIDE

- 7 RV Blade
- 7 Pole Round
- 6 Pole Round
- 6 Pole Square
- 5 Wire Flat
- 4 Wire Flat
- 4 Pole Round

TRAILER SIDE

3 CHOOSE YOUR PRODUCT

GOOD BETTER BEST

Provides Basic Towing Solutions

Provides Unique, Innovative Towing Solutions

Loaded With Performance Enhancements, ENDURANCE™ Products Set The New Standard For Quality

| PART # | DESCRIPTION | PART # | DESCRIPTION |
|--------|--|--------|--|
| 40930 | Connector, Endurance™ 7 Blade Twist Mount | 48145 | Connector, 4 Flat to 4-Wire Flat Extension, 12" |
| 40955 | Vehicle Wiring Kit, Multi-Tow® 7 Blade and 4 Flat | 48195 | Connector, Quick-Fix™ 4 Flat Set |
| 47185 | Vehicle Wiring Kit, Multi-Tow® 7 Blade and 4 Flat | 48215 | Connector, 4 Flat Set (48" Vehicle End, 12" Trailer End) |
| 47305 | Adapter, 6 Round to 4 Flat | 48245 | Connector, 4 Flat Trailer End Y-Harness, 20 feet |
| 47340 | Adapter, Endurance™ 7 Blade to 4 Flat with LED Test | 48435 | Connector, 6 Round Vehicle End |
| 47345 | Adapter, 7 Blade to 4 Flat with LED Test | 48445 | Connector, 6 Round Trailer End |
| 47355 | Adapter, 7 Blade to 4 Flat | 48480 | Connector, Endurance™ 7 Blade Vehicle End |
| 47385 | Adapter, 6 Round to 4 Flat | 48485 | Connector, 7 Blade Vehicle End |
| 47435 | Adapter, 6 Round to 7 Blade | 48505 | Connector, 7 Blade Trailer End |
| 47555 | Adapter, 7 Blade to 6 Round | 48510 | Connector, Endurance™ 7 Blade Trailer End |
| 47570 | Adapter, Endurance™ Multi-Tow® 7 Blade to 6 Round and 5/4 Flat | 48895 | Connector, Taillight Converter |
| 48030 | Connector, Endurance™ 4 Flat Vehicle End, 48" | 49915 | 4 Conductor Bonded Wire, 25 feet |
| 48110 | Connector, Endurance™ 4 Flat Trailer End, 12" | | |

27637 - LARGE STARTER ASSORTMENT (37 SKUs)



| PART # | DESCRIPTION | PART # | DESCRIPTION |
|--------|--|--------|--|
| 40930 | Connector, Endurance™ 7 Blade Twist Mount | 47715 | Brake Control Connector, (Ford 1994-2011) |
| 40955 | Vehicle Wiring Kit, Multi-Tow® 7 Blade and 4 Flat | 47755 | Brake Control Connector, (Dodge 1995-11) |
| 41125 | Vehicle Wiring Kit, Chev/GM | 47795 | Brake Control Connector, (Chev/GM, Cadillac, Hummer 1999-06) |
| 41135 | Vehicle Wiring Kit, Chev/GM/ISUZU | 48030 | Connector, Endurance™ 4 Flat Vehicle End, 48" |
| 42115 | Vehicle Wiring Kit, Dodge | 48110 | Connector, Endurance™ 4 Flat Trailer End, 12" |
| 47185 | Wiring Kit, 7 Blade and 4 Flat Multi-Tow® | 48145 | Connector, 4-Wire Flat to 4 Flat Extension, 12" |
| 47210 | Vehicle Wiring Kit, Endurance™ 7 Blade Quick Install | 48195 | Connector, Quick-Fix™ 4 Flat Set |
| 47235 | Impulse™ Brake Control - (Time-Based Digital) | 48215 | Connector, 4 Flat Set (48" Vehicle End, 12" Trailer End) |
| 47294 | Agility™ Brake Control - (Proportional Digital) | 48245 | Connector, 4 Flat Trailer End Y-Harness, 20 feet |
| 47305 | Adapter, 6 Round to 4 Flat | 48435 | Connector, 6 Round Vehicle End |
| 47340 | Adapter, Endurance™ 7 Blade to 4 Flat with LED Test | 48445 | Connector, 6 Round Trailer End |
| 47345 | Adapter, 7 Blade to 4 Flat with LED Test | 48480 | Connector, Endurance™ 7 Blade Vehicle End |
| 47355 | Adapter, 7 Blade to 4 Flat | 48485 | Connector, 7 Blade Vehicle End |
| 47385 | Adapter, Multi-Tow® 7 Blade to 5 & 4 Flat | 48510 | Connector, Endurance™ 7 Blade Trailer End |
| 47435 | Adapter, 6 Round to 7 Blade | 48505 | 7 Blade Trailer End |
| 47555 | Adapter, 7 Blade to 6 Round | 48615 | Connector, 7,9 Pole Mounting Bracket |
| 47565 | Adapter, 7 Blade to 6 Round and 4 Flat | 48895 | Connector, Taillight Converter (LED and Incandescent Compatible) |
| 47570 | Adapter, Endurance™ Multi-Tow® 7 Blade to 6 Round and 5/4 Flat | 49915 | 4 Conductor Bonded Wire, 25 feet |
| 47685 | Brake Control Connector, (Chev/GM 2007-13, Universal) | | |

STARTER KITS (LARGE)

FREQUENT QUESTIONS

We use our expertise to answer the towing questions we hear most. If you don't find the answer you're looking for here, feel free to contact our technical support team at (800) 835-0129.

CONVERTERS

Q: What is a converter?

A: Two types of taillight designs are found on vehicles - an independent bulb system and a common bulb system. If the brake light and turn signal operate from the same bulb, the taillight design is common. If the brake and turn work from separate bulbs, the design is independent. The industry standard found on trailers is a common bulb system. Vehicles will vary depending on the make and model. Any vehicle that has an independent bulb system must have a converter to "convert" the independent system to a common which is required on a trailer. A converter enables vehicles with independent brake lights and turn signals to provide proper lighting to the trailer.

Q: Why do I need a power converter?

A: Electronics on many newer vehicles are not equipped to handle the extra amp load that trailer lights require. A power converter provides power directly from the battery bypassing the electronics. This guarantees protection for sensitive electronics found on these vehicles.

Q: What is the reason for the battery lead wire on the power converter?

A: This wire provides the power to the trailer lights. Green / RT, yellow / LT, red / brake, and brown / taillights going to the power converter are only used as a signal. Once a function is used on the vehicle, the converter provides the actual power for the trailer lights from the battery. This allows us to bypass all the vehicle electronics to provide guaranteed safety.

FUSE BURN OUT

Q: Why am I blowing fuses on my vehicle?

A: Check all wires for bare copper or places where a wire could be pinched and calculate the amp load your trailer is pulling. Most vehicles are equipped to handle only standard lighting on trailers - one turn / brake signal on each side and one marker light on each front corner. Check your vehicle owner's manual for specific ratings.

GROUND PROBLEMS

Q: When I have my headlights on and apply the brakes, all the lights on my trailer go out. What causes this?

A: You have a ground problem. In your situation, you have a ground that is strong enough to provide some lighting functions but not all. This is called a weak ground. When the taillights and brake lights are used at the same time, it creates the maximum amp load of lights on the trailer. If a ground problem exists, it will show at this point. The places to check grounds are as follows:

1. The connector on the vehicle should have a ground wire secured tightly to a clean surface on the frame. A wire attached to the body or a surface with undercoating or rust can cause a ground problem.
2. The connector on the trailer should have a wire from the connector secured tightly to a clean surface on the trailer.
3. Each tail lamp assembly at the back of the trailer also must be grounded. This is done in one of two ways. The first is by a separate wire coming from the back of each tail lamp assembly being secured to the frame. The second, and most popular ground, is achieved through the bolts of the tail lamp assembly. In this case, the lamp housing must be attached to the frame of the trailer. If the lights are mounted on wood or PVC material, the light will not receive ground.
4. The last possibility to explore is in the trailer design. If the trailer has a tilting bed, it is possible the ground is not passing through the pivot point resulting in a poor ground. The solution to this is to route a ground wire from the connector at the front of the trailer to each lamp assembly at the back of the trailer bypassing this pivot point.

NOTE: The trailer hitched to the ball of the vehicle should never be considered sufficient ground.

Q: When I use one turn signal, the other one blinks. What causes this?

A: This is usually related to one of two things. The first could be a short somewhere in the system. All wiring, along with the vehicle connector, should be checked and tested. The second, which is the most common problem, is a weak ground in the system. Refer to the above question and follow steps one through four.

MISCELLANEOUS

Q: When my trailer is connected to my vehicle, the turn signals are dim and flashing rapidly. What causes this?

A: When you add trailer lights to a vehicle system, the turn signal amp load basically doubles. Most vehicles have a flasher that controls the blink of a turn signal. The standard flasher provided in many vehicles will not handle this extra load. You should replace your flasher with a heavy-duty flasher (8 to 10 amp) and make sure the vehicle engine is running. The flasher will slow down your turn signals and a running engine will increase brightness of the lamps.

BRAKE CONTROLS

Q: What is the difference between inertia activated and time based brake controls?

A: A time based brake control sends out your adjusted power setting over a set time frame with each depression of the brake pedal, regardless of how hard you press or how long you hold the brake pedal. An inertia based proportional controller activates the trailer brakes according to how much braking force was created while braking your vehicle. This ensures that the brake control is proportionally sending the same amount of power to the trailer brakes, mirroring the braking of the tow vehicle.

MISCELLANEOUS

Q: What is the 5th pin for on a 5 flat connector?

A: The 5th pin is for the reverse function.

Q: What is the difference between a towed vehicle wiring kit and a vehicle wiring kit?

A: Towed vehicle wiring kits are for wiring a vehicle to be towed behind a motorhome. Vehicle wiring kits are for wiring a vehicle to tow a trailer.

TOWING TIPS

1. Occasionally apply dielectric grease to all electrical terminals to prevent corrosion and ensure good continuity.
2. When testing to see if trailer lights are functioning, ensure trailer is connected to the ball mount of the vehicle hitch.
3. Always check all trailer lights before towing to ensure proper operation.
4. Always check battery level of the breakaway system before towing.

INDEX

| PART | PAGE | PART | PAGE | PART | PAGE | PART | PAGE |
|--------------|-----------|--------------|--------|------------|------|--------------|-------------------------|
| 02925..... | 93 | 20099..... | 26 | 40265..... | 56 | 40755..... | 60 |
| 03925..... | 93 | 20107..... | 27 | 40274..... | 56 | 40804..... | 60 |
| 03926..... | 92 | 20136..... | 30, 32 | 40275..... | 56 | 40805..... | 60 |
| 04025..... | 93 | 20146..... | 30, 31 | 40285..... | 56 | 40825..... | 60 |
| 04026..... | 92 | 20244..... | 30, 31 | 40305..... | 56 | 40905..... | 60 |
| 04115..... | 93 | 20245..... | 30, 31 | 40314..... | 56 | 40915..... | 61 |
| 05515..... | 93 | 20246..... | 30, 31 | 40315..... | 56 | 40920..... | 9, 52, 53, 61 |
| 08525..... | 93 | 20248..... | 30, 31 | 40324..... | 56 | 40925..... | 61 |
| 08526..... | 92 | 20286..... | 30, 31 | 40325..... | 57 | 40930.... | 8, 52, 53, 61, 124, 125 |
| 08540..... | 92 | 20400..... | 26 | 40335..... | 57 | 40935..... | 61 |
| 09025..... | 93 | 20407..... | 27 | 40345..... | 57 | 40940..... | 8, 52, 61 |
| 09515..... | 93 | 27627..... | 124 | 40355..... | 57 | 40941..... | 52 |
| 09516..... | 92 | 27637..... | 125 | 40375..... | 57 | 40950..... | 8, 52, 61 |
| 09528..... | 93 | 30000 | | 40385..... | 57 | 40951..... | 52 |
| 09615..... | 93 | 37908..... | 46 | 40395..... | 57 | 40955..... | 52, 61, 124, 125 |
| 09715..... | 93 | 37935..... | 39 | 40405..... | 57 | 40955B..... | 52 |
| 09815..... | 92 | 38038..... | 46 | 40415..... | 57 | 40959..... | 52 |
| 09915..... | 93 | 38118..... | 33 | 40425..... | 57 | 40965..... | 52, 61 |
| 09916..... | 92 | 38138..... | 33 | 40435..... | 58 | 40974..... | 52, 61 |
| 20000 | | 38438..... | 46 | 40444..... | 58 | 40975..... | 52, 61 |
| 20001..... | 26 | 38448..... | 32 | 40445..... | 58 | 40974B..... | 52 |
| 20005..... | 27 | 38487..... | 45 | 40455..... | 58 | 40978..... | 52 |
| 20007..... | 27 | 38508..... | 31 | 40464..... | 58 | 40985..... | 52 |
| 20008..... | 27 | 39035..... | 39 | 40465..... | 58 | 41000 | |
| 20010..... | 27 | 39045..... | 39 | 40475..... | 58 | 41105..... | 61 |
| 20011..... | 27 | 40000 | | 40485..... | 58 | 41115..... | 62 |
| 20014..... | 27 | 40105..... | 55 | 40495..... | 58 | 41120..... | 62 |
| 20022..... | 44, 45 | 40115..... | 55 | 40504..... | 58 | 41125..... | 62, 125 |
| 20031..... | 35 | 40125..... | 55 | 40505..... | 59 | 41135..... | 62, 125 |
| 20033..... | 30, 32 | 40135..... | 55 | 40514..... | 59 | 41144..... | 62 |
| 20034..... | 30, 32 | 40145..... | 55 | 40525..... | 59 | 41145..... | 62 |
| 20036..... | 30, 32 | 40147..... | 9, 85 | 40535..... | 59 | 41150..... | 62 |
| 20042..... | 30, 31 | 40155..... | 55 | 40545..... | 59 | 41151..... | 84 |
| 20043..... | 30, 31 | 40157..... | 9, 85 | 40554..... | 59 | 41155..... | 62 |
| 20044..... | 30, 31 | 40165..... | 55 | 40555..... | 59 | 41157..... | 9, 84 |
| 20045..... | 30, 31 | 40167..... | 9, 85 | 40565..... | 59 | 41164..... | 62 |
| 20047..... | 30, 31 | 40175..... | 55 | 40575..... | 59 | 41165..... | 62 |
| 20048..... | 30, 31 | 40177..... | 9, 85 | 40585..... | 59 | 41174..... | 62 |
| 20049..... | 8, 12, 16 | 40185..... | 55 | 40595..... | 59 | 41175..... | 62 |
| 20050..... | 27 | 40195..... | 55 | 40605..... | 59 | 41185..... | 63 |
| 20051..... | 27 | 40205..... | 55 | 40615..... | 60 | 41195..... | 63 |
| 20052..... | 27 | 40215..... | 55 | 40655..... | 60 | 41204..... | 63 |
| 20059..... | 27 | 40235..... | 56 | 40665..... | 60 | 41205..... | 63 |
| 20060..... | 27 | 40245..... | 56 | 40685..... | 60 | 41215..... | 63 |
| 20086..... | 31 | 40254..... | 56 | 40695..... | 60 | 41225..... | 63 |
| 20087..... | 31 | 40264..... | 56 | 40735..... | 60 | 41235..... | 63 |

INDEX (CONTINUED)

| PART | PAGE | PART | PAGE | PART | PAGE | PART | PAGE |
|------------|------|--------------|-----------|--------------|------|--------------|-------|
| 41245..... | 63 | 41815..... | 67 | 42255..... | 71 | 43185..... | 75 |
| 41254..... | 63 | 41820..... | 67 | 42265..... | 71 | 43195..... | 75 |
| 41255..... | 63 | 41824..... | 67 | 42274..... | 71 | 43205..... | 75 |
| 41265..... | 63 | 41825..... | 68 | 42275..... | 71 | 43215..... | 75 |
| 41275..... | 63 | 41835..... | 68 | 42285..... | 71 | 43225..... | 75 |
| 41285..... | 64 | 41844..... | 68 | 42295..... | 71 | 43254..... | 75 |
| 41295..... | 64 | 41845..... | 68 | 42304..... | 71 | 43255..... | 75 |
| 41300..... | 64 | 41854..... | 68 | 42305..... | 72 | 43264..... | 75 |
| 41304..... | 64 | 41855..... | 68 | 42315..... | 72 | 43265..... | 75 |
| 41305..... | 64 | 41875..... | 68 | 42345..... | 72 | 43270..... | 76 |
| 41310..... | 64 | 41905..... | 68 | 42355..... | 72 | 43274..... | 76 |
| 41315..... | 64 | 41915..... | 68 | 42365..... | 72 | 43275..... | 76 |
| 41325..... | 64 | 41920..... | 68 | 42375..... | 72 | 43285..... | 76 |
| 41335..... | 64 | 41925..... | 68 | 42385..... | 72 | 43314..... | 76 |
| 41345..... | 64 | 41930..... | 68 | 42415..... | 72 | 43315..... | 76 |
| 41355..... | 65 | 41935..... | 69 | 42435..... | 72 | 43325..... | 76 |
| 41365..... | 65 | 41940..... | 69 | 42455..... | 72 | 43335..... | 76 |
| 41374..... | 65 | 41945..... | 69 | 42464..... | 72 | 43345..... | 76 |
| 41375..... | 65 | 41954..... | 69 | 42465..... | 73 | 43355..... | 76 |
| 41384..... | 65 | 41955..... | 69 | 42475..... | 73 | 43365..... | 76 |
| 41385..... | 65 | 41964..... | 69 | 42485..... | 73 | 43374..... | 77 |
| 41395..... | 65 | 41965..... | 69 | 42515..... | 73 | 43375..... | 77 |
| 41405..... | 65 | 41974..... | 69 | 42525..... | 73 | 43384..... | 77 |
| 41415..... | 65 | 41975..... | 69 | 42535..... | 73 | 43385..... | 77 |
| 41425..... | 65 | 41985..... | 69 | 42545..... | 73 | 43395..... | 77 |
| 41434..... | 65 | 41995..... | 69 | 42555..... | 73 | 43397..... | 9, 85 |
| 41435..... | 66 | 42000 | | 42565..... | 73 | 43405..... | 77 |
| 41474..... | 66 | 42104..... | 70 | 42605..... | 73 | 43415..... | 77 |
| 41475..... | 66 | 42105..... | 70 | 42615..... | 73 | 43425..... | 77 |
| 41485..... | 66 | 42115..... | 70, 125 | 42625..... | 73 | 43435..... | 77 |
| 41495..... | 66 | 42125..... | 70 | 42635..... | 74 | 43445..... | 77 |
| 41555..... | 66 | 42135..... | 70 | 42645..... | 74 | 43455..... | 77 |
| 41565..... | 66 | 42137..... | 9, 85 | 42705..... | 74 | 43465..... | 77 |
| 41575..... | 66 | 42145..... | 53, 70 | 43000 | | 43475..... | 78 |
| 41585..... | 66 | 42155..... | 70 | 43024..... | 89 | 43485..... | 78 |
| 41595..... | 66 | 42165..... | 70 | 43104..... | 74 | 43495..... | 78 |
| 41605..... | 66 | 42175..... | 70 | 43105..... | 74 | 43500 | |
| 41615..... | 66 | 42190..... | 8, 53, 70 | 43114..... | 74 | 43505..... | 78 |
| 41625..... | 67 | 42191..... | 52 | 43115..... | 74 | 43515..... | 78 |
| 41645..... | 67 | 42195..... | 70 | 43124..... | 74 | 43535..... | 78 |
| 41705..... | 67 | 42205..... | 70 | 43125..... | 74 | 43565..... | 78 |
| 41725..... | 67 | 42214..... | 71 | 43135..... | 74 | 43574..... | 78 |
| 41745..... | 67 | 42215..... | 71 | 43145..... | 74 | 43575..... | 78 |
| 41765..... | 67 | 42225..... | 71 | 43155..... | 75 | 43585..... | 78 |
| 41775..... | 67 | 42235..... | 71 | 43165..... | 75 | 43595..... | 78 |
| 41795..... | 67 | 42245..... | 71 | 43175..... | 75 | 43605..... | 78 |

INDEX (CONTINUED)

| PART | PAGE | PART | PAGE | PART | PAGE | PART | PAGE |
|------------|------|--------------|------------------|-------------|----------------------|-------------|-----------------------------|
| 43624..... | 79 | 43934..... | 82 | 47200..... | 8, 44, 45 | 47555B..... | 15 |
| 43625..... | 79 | 43935..... | 83 | 47204..... | 45 | 47565..... | 12, 13, 15, 125 |
| 43645..... | 79 | 43944..... | 83 | 47205..... | 44, 45 | 47565B..... | 13, 15 |
| 43675..... | 79 | 43945..... | 83 | 47210..... | 8, 44, 45, 125 | 47570.. | 8, 12, 13, 14, 15, 124, 125 |
| 43685..... | 79 | 43954..... | 83 | 47214..... | 45 | 47575..... | 12, 13, 15 |
| 43690..... | 79 | 43955..... | 83 | 47225..... | 23 | 47575B..... | 13, 15 |
| 43704..... | 79 | 43964..... | 83 | 47235..... | 23, 125 | 47585..... | 12, 13, 15 |
| 43705..... | 79 | 43965..... | 83 | 47275..... | 24 | 47595..... | 12, 16 |
| 43715..... | 79 | 43975..... | 83 | 47284..... | 23 | 47605..... | 19 |
| 43720..... | 79 | 43984..... | 83 | 47285..... | 23 | 47625..... | 24 |
| 43724..... | 79 | 43985..... | 83 | 47294..... | 23, 125 | 47635..... | 25 |
| 43725..... | 79 | 43994..... | 83 | 47295..... | 23 | 47675..... | 12, 13, 14, 16 |
| 43735..... | 80 | 43995..... | 83 | 47297..... | 22, 23 | 47685..... | 25, 125 |
| 43744..... | 80 | 46000 | | 47305..... | 12, 17, 124, 125 | 47695..... | 24 |
| 43745..... | 80 | 46105..... | 44, 46 | 47305B..... | 17 | 47705..... | 24 |
| 43754..... | 80 | 46155..... | 48 | 47315..... | 12, 17 | 47705B..... | 24 |
| 43755..... | 80 | 46255..... | 48 | 47320..... | 8, 12, 17 | 47715..... | 25, 125 |
| 43764..... | 80 | 46345..... | 48 | 47325..... | 12, 17 | 47725..... | 24 |
| 43765..... | 80 | 46365..... | 48 | 47335..... | 12, 13 | 47735..... | 25 |
| 43784..... | 80 | 46375..... | 48 | 47340..... | 8, 12, 13, 124, 125 | 47745..... | 24 |
| 43785..... | 80 | 47000 | | 47345..... | 12, 13, 124, 125 | 47745B..... | 24 |
| 43795..... | 80 | 47015..... | 9, 12, 13 | 47345B..... | 13 | 47755..... | 25, 125 |
| 43804..... | 80 | 47043..... | 9, 12, 16, 88 | 47355..... | 12, 13, 124, 125 | 47775..... | 24 |
| 43805..... | 80 | 47044..... | 16, 88 | 47355B..... | 13 | 47775B..... | 24 |
| 43814..... | 81 | 47045..... | 9, 12, 18, 88 | 47365..... | 12, 13 | 47795..... | 25, 125 |
| 43815..... | 81 | 47046..... | 18, 88 | 47365B..... | 13 | 47805..... | 24 |
| 43820..... | 81 | 47047..... | 16, 88 | 47375..... | 12, 14 | 47815..... | 25 |
| 43824..... | 81 | 47053..... | 9, 12, 16, 88 | 47375B..... | 14 | 47825..... | 24 |
| 43825..... | 81 | 47054..... | 16, 88 | 47385..... | 12, 13, 14, 124, 125 | 47835..... | 24 |
| 43834..... | 81 | 47055..... | 9, 12, 18, 88 | 47385B..... | 13, 14 | 47845..... | 25 |
| 43835..... | 81 | 47056..... | 18, 88 | 47390..... | 8, 12, 14 | 47855..... | 25 |
| 43855..... | 81 | 47057..... | 16, 88 | 47405..... | 12, 17 | 47865..... | 24 |
| 43865..... | 81 | 47065..... | 9, 12, 13 | 47405B..... | 17 | 47875..... | 25 |
| 43874..... | 81 | 47075..... | 9, 12, 14 | 47407..... | 12, 17 | 47890..... | 8, 30, 35 |
| 43875..... | 81 | 47083..... | 9, 12, 15 | 47415..... | 12, 18 | 47895..... | 30, 35 |
| 43884..... | 82 | 47085..... | 9, 12, 15 | 47425..... | 12, 17 | 47900..... | 9, 44, 46 |
| 43885..... | 82 | 47105..... | 12, 19 | 47435..... | 12, 18, 124, 125 | 47905..... | 44, 46 |
| 43894..... | 82 | 47105B..... | 19 | 47435B..... | 18 | 47905B..... | 46 |
| 43895..... | 82 | 47115..... | 12, 19 | 47445..... | 12, 17 | 47910..... | 8, 30, 32 |
| 43900..... | 82 | 47115B..... | 19 | 47465..... | 12, 18 | 47913..... | 30, 32 |
| 43905..... | 82 | 47155..... | 44, 46 | 47515..... | 12, 19 | 47915..... | 30, 32 |
| 43910..... | 82 | 47165..... | 44, 45 | 47525..... | 12, 15 | 47925..... | 24 |
| 43914..... | 82 | 47175..... | 44, 45 | 47535..... | 12, 15 | 47935..... | 25 |
| 43915..... | 82 | 47180..... | 8, 44, 45 | 47545..... | 12, 15 | 47945..... | 30, 39 |
| 43924..... | 82 | 47185..... | 44, 45, 124, 125 | 47545B..... | 15 | 47955..... | 30, 39 |
| 43925..... | 82 | 47185B..... | 45 | 47555..... | 12, 15, 124, 125 | 47965..... | 30, 39 |

INDEX (CONTINUED)

| PART | PAGE | PART | PAGE | PART | PAGE | PART | PAGE |
|--------------|-----------------------|--------------|---------------------|----------------------|--------|-------|------|
| 47965B | 39 | 48425 | 44, 46 | 50000 / 51000 | | 56102 | 89 |
| 47975 | 30, 35 | 48430 | 9, 44, 45 | 50002 | 42 | 56103 | 89 |
| 47985 | 30, 35 | 48435 | 44, 46, 124, 125 | 50002D | 43 | 56104 | 89 |
| 47995 | 30, 35 | 48435B | 46 | 50918 | 38 | 56105 | 89 |
| 48000 | | 48440 | 8, 30, 32 | 50928 | 38 | 56106 | 89 |
| 48005 | 44, 47 | 48445 | 30, 32, 124, 125 | 50944 | 38 | 56107 | 89 |
| 48015 | 44, 47 | 48445B | 32 | 51000 | 39 | 56109 | 89 |
| 48025 | 44, 46 | 48465 | 30, 34 | 51010 | 39 | 56200 | 89 |
| 48030 | 9, 44, 46, 124, 125 | 48470 | 8, 44, 45 | 51020 | 39 | 56202 | 89 |
| 48035 | 44, 47 | 48480 | 8, 44, 45, 124, 125 | 52000 | | 56203 | 89 |
| 48035B | 47 | 48480B | 45 | 52002 | 30, 39 | 56204 | 89 |
| 48045 | 44, 47 | 48485 | 44, 45, 124, 125 | 52004 | 44, 47 | 56205 | 89 |
| 48055 | 44, 46 | 48485B | 45 | 52006 | 30, 33 | 56206 | 89 |
| 48065 | 44, 47 | 48495 | 44, 45 | 52007 | 30, 35 | 56207 | 89 |
| 48095 | 47 | 48500 | 8, 30, 31 | 52008 | 30, 32 | 56300 | 89 |
| 48105 | 30, 33 | 48502 | 30, 31 | 52016 | 44, 45 | 56301 | 89 |
| 48110 | 9, 30, 33, 124, 125 | 48503 | 30, 31 | 52024 | 30, 31 | 56302 | 89 |
| 48115 | 30, 33 | 48505 | 30, 31, 124, 125 | 52027 | 30, 32 | 56303 | 89 |
| 48115B | 33 | 48505B | 31 | 53000 | | 56304 | 89 |
| 48125 | 32, 33 | 48510 | 8, 30, 31, 124, 125 | 53015 | 25 | 56305 | 89 |
| 48133 | 30, 33 | 48515 | 30, 31 | 53025 | 24 | 56306 | 89 |
| 48135 | 30, 33 | 48595 | 47 | 53035 | 25 | 56307 | 89 |
| 48135B | 33 | 48605 | 19, 47 | 53045 | 24 | | |
| 48143 | 12, 19 | 48605B | 47 | 53055 | 25 | | |
| 48145 | 12, 19, 124, 125 | 48615 | 47, 125 | 53056 | 25 | | |
| 48165 | 35 | 48615B | 47 | 53057 | 24 | | |
| 48175 | 30, 35 | 48655 | 38 | 53065 | 24 | | |
| 48190 | 9, 44, 46 | 48675 | 38 | 53075 | 25 | | |
| 48192 | 9, 30, 33 | 48705 | 38 | 53085 | 24 | | |
| 48195 | 30, 35, 124, 125 | 48709 | 38 | 55000 | | | |
| 48205 | 30, 35 | 48715 | 38 | 55110 | 30, 39 | | |
| 48215 | 30, 35, 124, 125 | 48735 | 39 | 55115 | 30, 39 | | |
| 48235 | 12, 19 | 48755 | 47 | 55120 | 30, 39 | | |
| 48240 | 9, 30, 34, 122 | 48895 | 48, 124, 125 | 55125 | 30, 39 | | |
| 48245 | 30, 34, 122, 124, 125 | 48955 | 89 | 55999 | 89 | | |
| 48255 | 30, 34, 122 | 49000 | | 56000 | | | |
| 48255B | 34 | 49015 | 39 | 56000 | 89 | | |
| 48265 | 30, 34, 122 | 49905 | 39 | 56001 | 89 | | |
| 48285 | 30, 35 | 49915 | 39, 124, 125 | 56002 | 89 | | |
| 48295 | 30, 35 | 49955 | 39 | 56003 | 89 | | |
| 48305 | 44, 47 | 49975 | 39 | 56004 | 89 | | |
| 48325 | 30, 33 | | | 56005 | 89 | | |
| 48345 | 30, 35 | | | 56007 | 89 | | |
| 48365 | 44, 46 | | | 56008 | 89 | | |
| 48385 | 30, 32 | | | 56100 | 89 | | |
| 48405 | 30, 34 | | | 56101 | 89 | | |

INFORMATION

CONTACT TECH SUPPORT (800) 835-0129

FAX: (800) 444-6779

EMAIL: techsupport@HopkinsMfg.com

CONTACT DEALER SUPPORT (800) 524-1458

EMAIL: sales@HopkinsMfg.com



Hopkins Manufacturing Corporation 428 Peyton, P.O. Box 1157
Emporia, Kansas 66801-1157 (620) 342-7320
www.HopkinsMfg.com | www.HopkinsTowingSolutions.com

SPECIAL ORDER PROGRAM

Most of our towing part numbers are available through our special order program. This program provides immediate access to new applications as well as older, slower moving items not carried in your regular inventory. The availability of these applications enables Hopkins® and its representatives to provide the best service possible to customers and consumers.

ORDER REQUIREMENT

1-2 pieces MAXIMUM.

ORDERS *(Fax or email orders are preferred.)*

All orders received and verified by 1:00 P.M. CT (Mon.-Fri.) will be shipped same day.

PRICING

All items will be priced at WD (Warehouse Distributor) pricing (NO discounts) and are subject to change without notice.

SHIPPING

Actual freight charges will be applied. Orders will be shipped FedEx ground unless specified otherwise. Any additional shipping charges will be paid by the customer. Shipping charges on returns will be paid by the customer.

TERMS

The invoiced amount is due on regular terms after the billing date.

PHONE: (800) 524-1458

FAX: (800) 444-6779

EMAIL: SpecialOrders@hopkinsmfg.com

LIMITED WARRANTY

Hopkins Manufacturing Corporation warrants **InSIGHT™, Agility™, Reliance™, Brake-Force™ and Impulse™ brake control products** to be free from defects in material and workmanship, under normal use and service, for the original buyer's lifetime from the date of original purchase.

Hopkins Manufacturing Corporation warrants **Endurance™ products** to be free from defects in material and workmanship, under normal use and service, for the original buyer, for a period of 3 years from the date of original purchase.

Hopkins Manufacturing Corporation warrants all Hopkins® towing products to be free from defects in material and workmanship, under normal use and service, for the original buyer, for a period of 90 days from the date of original purchase.

This warranty does not cover, and Hopkins Manufacturing Corporation is not liable for, the cost of repair or replacement of parts which have been subjected to misuse, negligence, accident, improper installation, modification, or normal deterioration due to wear and exposure, or defects caused by unauthorized repairs. THE ORIGINAL BUYER'S EXCLUSIVE REMEDIES UNDER THIS LIMITED WARRANTY SHALL BE LIMITED TO REPAIR OR REPLACEMENT (AT THE OPTION OF HOPKINS MANUFACTURING CORPORATION) OF THE DEFECTIVE PRODUCT OR PART. The repair or replacement of the product or part under warranty will be made by Hopkins Manufacturing Corporation without charge for parts or labor.

ALL WARRANTIES IMPLIED BY LAW, INCLUDING BUT NOT LIMITED TO WARRANTIES FOR MERCHANTABILITY AND FITNESS FOR A PARTICULAR PURPOSE, ON DEFECTS IN THE MATERIAL AND WORKMANSHIP SHALL BE EFFECTIVE ONLY FOR A PERIOD OF 90 DAYS FROM THE DATE OF PURCHASE. Some states do not allow limitations on how long an implied warranty lasts, so the above limitations may not apply to you.

UNDER NO CIRCUMSTANCES WILL HOPKINS MANUFACTURING CORPORATION BE LIABLE FOR INCIDENTAL OR CONSEQUENTIAL DAMAGES, INCLUDING BUT NOT LIMITED TO DAMAGE TO OR LOSS OF OTHER PROPERTY OR EQUIPMENT. Some states do not allow the exclusion or limitation of incidental or consequential damages, so the above limitations or exclusions may not apply to you. This warranty gives you specific legal rights, and you may also have other rights which vary from state to state.

In order to obtain performance under this warranty, return the defective product, postage prepaid, along with dated proof of purchase, to Hopkins Manufacturing Corporation, 428 Peyton, Emporia, Kansas 66801-1157. This warranty does not cover shipping and delivery charges to or from Hopkins Manufacturing Corporation.

THE FOLLOWING LIST OF PRODUCT NAMES AND BRANDS ARE THE TRADEMARKS OR REGISTERED TRADEMARKS OF HOPKINS MANUFACTURING CORPORATION UNLESS OTHERWISE NOTED, ALL RIGHTS RESERVED

Hopkins Towing Solutions®, Hopkins®, Plug-in Simple®, Multi-Tow®, Endurance™, Quick-Change™, Quick Install™, Flex-Coil™, Flex-CoilHD™, Nite-Glow™, Quick-Fix™, Mag-Flat™, Flat-Lite™, InSIGHT™, Flex-Mount™, Flex-Display™, Flex-Control™, Smart Box™, SmartZone™, Brake-Force™, Impulse™, Reliance™, Agility™, Smart Hitch™, Engager™, Tow Doctor™, Never Fade™, Level+Plus™, Level Light™, Mag-Strap™, Quick-Lock™

9-IN-10 D.I.Y. SHOPPERS CHOOSE HOPKINS®

ISO certified facility
dedicated to vehicle
to trailer wiring

Meets or exceeds SAE
standards for best
quality performance

Constantly striving to
make the consumers' experience
easier and better

Unmatched new product solutions
for more than a quarter century

FACT: 40% of all towing
electrical retail sales are
proprietary Hopkins innovations

Best category insights
for optimum planogram mix

Responsive supply chain
consistently provides
the highest fill rates

Dedicated team of
Technical Specialists
for after sale support



THE GOLD STANDARD



HOPKINS MANUFACTURING CORPORATION
428 Peyton Street - P.O. Box 1157 - Emporia, KS 66801-1157
(620) 342-7320 - www.HopkinsMfg.com

800-1878-016 - Rev. A - Printed in U.S.A.